AMP1-16V Series

- AMP1-16V-MD
- AMP1-E16V-MD

1RU, 3Gb/s, 16-Channel, Audio and Video Monitor

User Guide
(Software Version: 3.2x)

Part Number 821697, Revision P



31055 Huntwood Avenue
Hayward, California
94544 USA



1 800 5 WOHLER
+1 (510) 870-0810
Fax +1 (510) 870-0811



www.wohler.com
info@wohler.com



© 2013 Wohler Technologies, Inc. and PANORAMA. All rights reserved.

This publication is protected by federal copyright law. No part of this publication may be copied or distributed, stored in a retrieval system, or translated into any human or computer language in any form or by any means electronic, mechanical, manual, magnetic, or otherwise, or disclosed to third parties without the express written permission of Wohler Technologies.

Reproduction

Licensed users and authorized distributors of Wohler Technologies, Inc. products may copy this document for use with Wohler Technologies, Inc. products provided that the copyright notice above is included in all reproductions.

Customer Support

Wohler Technologies, Inc.
31055 Huntwood Avenue
Hayward, CA 94544
www.wohler.com

Phone: 510-870-0810
FAX: 510-870-0811
US Toll Free: 1-888-596-4537
(1-888-5-WOHLER)
Web: www.wohler.com
Sales: sales@wohler.com
Support: support@wohler.com

Disclaimers

Even though Wohler Technologies, Inc. has tested its equipment and software, and reviewed the documentation, Wohler Technologies, Inc makes no warranty or representation, either express or implied, with respect to software, documentation, their quality, performance, merchantability, or fitness for a particular purpose.

In no event will Wohler Technologies, Inc. be liable for direct, indirect, special, incidental, or consequential damages resulting from any defect in the hardware, software, or its documentation, even if advised of the possibility of such damages.

Some states do not allow the exclusion or limitation for incidental or consequential damages, so the above exclusion or limitation may not apply to you.

Printing

This document is intended to be printed on a duplex printer, such that the copy appears on both sides of each page. This ensures that all new chapters start on a right-facing page.

This document looks best when printed on a color printer since some images may be indistinct when printed on a black and white printer.

PDF

All text strings appearing in [this shade of blue](#) are hyperlinks.

Other Technologies and Products

Dolby is a registered trademark of Dolby Laboratories, Inc.

Microsoft Windows, and Internet Explorer are registered trademarks of Microsoft Corporation.

Last Update

September 22, 2014

Table of Contents

Chapter 1. Quick Start.....	1
Introduction	1
Overview.....	1
Topics	1
Safety Instructions	2
Installation Recommendations.....	3
Mounting.....	3
Heat Dissipation	3
Power	3
Compliance	4
FCC	4
IC-ECES-003	4
Using the Monitor.....	4
Front Panel.....	5
Back Panel.....	6
Getting Started	7
Configuring the System.....	9
Chapter 2. The “How Do I...” Chapter.....	11
Introduction	11
Overview.....	11
Topics	11
Notation.....	12
Frequently Asked Questions.....	13
How do I Select the Inputs I Want to Hear in the Speakers?	13
How do I Decode and Monitor a Dolby Bitstream?	14
How do I Decode and Monitor a Dolby Bitstream (Continued)?.....	15

How do I Cluster Meter Pairs Together for Easy Readability?	16
How do I Customize the Meter Scales?.....	17
How do I Configure a Hot Key to Solo a Cluster?	18
How do I Configure a Hot Key to Mute a Cluster?	19
How do I Configure the AES and Analog Outputs?.....	21
How do I Set Up for External Surround Sound?.....	23
How Do I Sync Internal Speaker Audio with an External Video Monitor?	24
How Do I Use Presets to Change Inputs?	25
How Do I Quickly Recall Presets from the Main Screen?.	26
How do I Display the Loudness of a Cluster of Channels? .	27
How do I Display Dolby Metadata instead of Video?.....	29
How do I Display Dolby Metadata Along With Video?.....	30
How do I Adjust the Screen Saver or Screen Brightness? .	31
How Do I Terminate or Untermine AES Inputs?	32
How do I Find Software Version Information?	33

Chapter 3. Audio and Metering. 35

Introduction.....	35
Overview	35
Topics	35
Configuration Options	36
Configuring the Audio Outputs.....	36
Overview	36
Surround Sound	37
Stereo Downmix.....	38
AES and Analog Outputs	41
Level Metering	44
Overview	44
Metering Menus	45

Chapter 4. Video and Data 47

Introduction	47
Overview	47
Topics	47
Configuration Options	48
Overview	48
Video Menus	49

Chapter 5. Efficiency Enhancements 51

Introduction	51
Overview	51
Topics	51
Presets	52
Overview	52
Saving Presets	52
Recalling Presets	52
Naming or Renaming	53
Clearing a Preset	54
Recalling a Preset On Power Up	55
Hot Keys	55
Overview	55
Mutes and Solos	55
Defining/Modifying a Hot Key	56
Creating a Preset Hot Key	57
Naming/Renaming a Hot Key	57
Copying Presets to Another Monitor	58
Preset Files	58
Verifying Compatibility	59
Backing Up the Saved Presets	61
Copying the Presets to Another Monitor	61
General Purpose Inputs and Outputs (GPI/Os).....	62

Turning Active Help On or Off63

Chapter 6. Menu List. 65

Introduction.....65
 Overview65
 Topics65
Menu Navigation Overview.....66
AES Output Configuration Menu.....68
Analog Output Configuration Menu70
Configuration Selection Menu72
Cluster Configuration Menu73
Dolby Setup Menu74
Hardware Configuration Menu75
Label Menu Screen77
Loudness Configuration Menu Screen78
Main Screen.....79
Main Screen Hot Key Button Configuration Menu81
Meter Configuration Menu82
Monitor Mixer Configuration Menu84
Option Configuration Menu.....86
Preset Management Menu.....87
Screen Display Menu.....88
Screen Information Setup Menu89
Unit Information Menu91

Chapter 7. Firmware Updates. 93

Introduction.....93
 Overview93
 Topics93
Upgrade Requirements94
Comparing Firmware Versions94
Upgrading the Netburner Software.....96

Upgrading the Sub-Processor Firmware	98
Chapter 8. Features and Specifications.	105
Introduction	105
Overview	105
Topics	105
Features	106
Product Benefits	106
Distinction Between Models	107
Additional Features	107
Compliance	108
Standards	108
Specifications	108
Technical Functional Overview	110
Appendix 9. Establishing Connectivity	113
Introduction	113
Overview	113
Topics	113
Connectivity Options	114
Connecting to a LAN	114
Launching the Setup Tool	114
Setting a Static Ethernet Configuration	115
Connecting Directly	117
Using AutoIP	117
Setting a Static IP in the AMP1-16V	120
Setting a Static IP in a Windows XP Computer	121
Setting a Static IP in a Windows 7 Computer	126
Appendix 10. Setting Up File Transfers.	131
Introduction	131

Overview	131
Topics	131
Navigating to the Unit Information Menu	132
Enabling FTP Access.....	133

CHAPTER 1

Quick Start

Introduction

Overview

The AMP1-16V-MD and AMP1-E16V-MD are Wohler's first 1RU, 16-channel, 3G audio/video monitors. These units come with three 2.4" video screens and an easy-to-use configuration interface that provides flexible audio metering, video monitoring, and other data display.

Topics

Topics	Page
Quick Start	1
Safety Instructions	2
Installation Recommendations	3
Compliance	4
Using the Monitor	4
Getting Started	7
Configuring the System	9

Safety Instructions

1. Read, keep, and follow all of these instructions; heed all warnings.
2. Do not use this equipment near water.
3. Use only a dry cloth to clean the equipment.
4. Do not block any ventilation openings. Install only in accordance with the instructions in the section entitled, “[Installation Recommendations](#)” on [page 3](#).
5. Do not install near any heat source such as a radiator, heat register, amplifier, or stove.
6. Do not expose the equipment to rain or moisture.
7. Do not attempt to plug the unit into a two-blade outlet (with only two prongs of equal width).

IMPORTANT: By design, this monitor will only plug into a three-prong outlet for your safety. If the plug does not fit into your outlet, contact an electrician to replace the obsolete outlet.

8. Protect the power cord from being walked on or pinched, particularly at plug's source on the equipment and at the socket.
9. Use only the attachments/accessories specified by the manufacturer.
10. Unplug the equipment during lightning storms or when unused for long periods of time.
11. Refer all servicing to qualified service personnel. Servicing will be required under all of the following conditions:
 - The equipment has been damaged in any way, such as when the power-supply cord or plug is damaged.
 - Liquid had been spilled or objects have fallen onto the equipment.
 - The equipment has been exposed to rain or moisture.
 - The equipment does not operate normally.
 - The equipment has been dropped.

Installation Recommendations

Mounting

The unit is designed to install into a standard 19" rack, mounted at eye level for best visual observation of the monitor screens. After installing the AMP1-16V-MD, remove the clear, plastic protective covers from each screen using the tabs provided.

Heat Dissipation

The ambient temperature inside the mounting enclosure should not exceed 40° Celsius (104° Fahrenheit). Adjacent devices can be rack mounted (or stacked) in proximity to the unit if the above temperature is not exceeded. If the product must be operated in an environment with an elevated temperature, allow a 1RU (1.75" / 44.45mm) space above and below the unit for air circulation.

Important: To reduce noise, neither the AMP1-16V-MD nor the AMP1-E16V-MD have any fans. As a result, the heat generated by the class D power amplifiers, power supplies, and other components is vented by slots in the sides of the unit. Therefore, as a safety precaution, we advise you to be sure to allow proper ventilation on both sides of the unit.

Power

The AMP1-16V-MD has a standard IEC connector on the rear panel from which it can connect to AC mains power (100 to 240 VAC ± 10%, 50/60 Hz, 65W). You may use the power cord provided, or another approved cord, to adapt the unit to the proper country-specific power connection.

Compliance

FCC

This equipment has been tested and found to comply with the limits for a Class A digital device, pursuant to part 15 of the FCC Rules. These limits are designed to provide reasonable protection against harmful interference when the equipment is operated in a commercial environment. This equipment generates, uses, and can radiate radio frequency energy and, if not installed and used in accordance with the instruction manual, may cause harmful interference to radio communications. Operation of this equipment in a residential area is likely to cause harmful interference in which case the user will be required to correct the interference at his own expense.

IC-ECES-003

This Class A digital apparatus complies with Canadian ICES-003.

Cet appareil numérique de la classe A est conforme à la norme NMB-003 du Canada.

Using the Monitor

This section provides a brief overview of the controls on the front panel, and the connectors on the back panel of the monitor.

Front Panel

Figure 1-1 Front Panel Layout

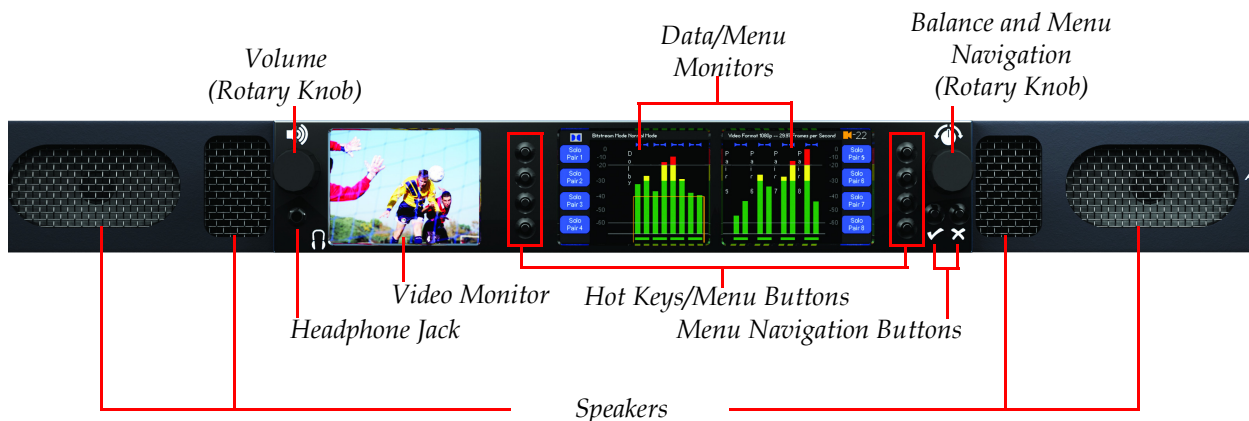

Speakers: Audio monitoring is achieved through the use of class D amplifiers driving two (left/right) wide range speakers.

Headphone Jack: A class B amplifier drives the front panel 3.5 mm jack for an optional headphone.

Balance and Volume Rotary Knobs: Control knobs are on the left and right of the front panel video displays. The left knob controls the **Volume** and the speaker output and can be programmed to control the AES and Analog outputs. Pressing this control drops the internal speaker volume by 20 dB. Pressing it a second time mutes the internal speakers entirely. Pressing it a third time brings the internal speaker volume back to normal. Turning the knob to increase the volume increases it from the current volume, whether from the 20dB dip or from the completely muted state.

The right knob adjusts the **Balance** between the speakers. Pressing the knob returns the audio balance to center. This knob is also used for setting adjustments when programming the options and features in the configuration menus.

Video Screen: This monitor (left) displays either video and/or data such as help for the **Menu and Data Screens**.

Menu and Data Screens: These two screens on the right work together to display bar graphs and the configuration menus.

Hot Keys/Push Buttons: Ten buttons are used for menu navigation and hot key access to solo, mute, and preset functions.

Back Panel

The AMP1-16V-MD and AMP1-E16V-MD back panel contains all of the connectors except for the headphone jack as shown in [Figure 1-2](#) below.

Figure 1-2 Back Panel Layout

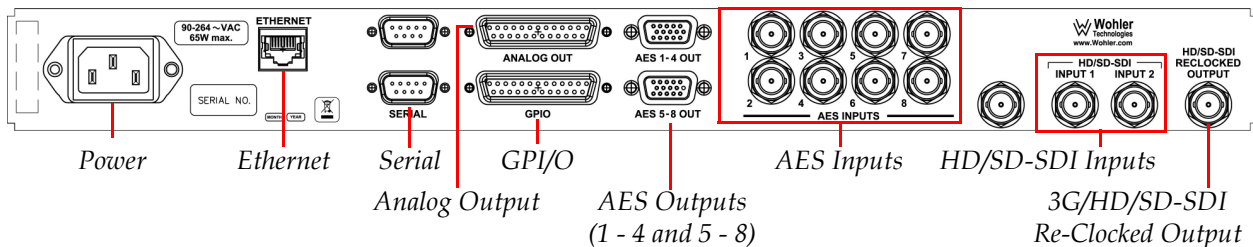

- **Power:** The AMP1-16V-MD and AMP1-E16V-MD use a standard IEC power cord for the 100 to 240 VAC power connection.
- **Ethernet:** The Ethernet port is used for system software upgrades.
- **Serial:** This DB-9F connector is used for system software upgrades.
- **Analog Outputs:** This DB-25F connector provides eight channels of balanced analog outputs. The source of these signals is controlled by the setup menus. (The pin out of this connector is shown in [Table 3-3 on page 43](#).)
- **AES Outputs:** Each of these two HD-15F connectors supplies four pairs of unbalanced AES outputs for a total of eight. The source of these signals is determined by the setup menus. (The pin out of these connectors is shown in [Table 3-2 on page 42](#).)
- **AES Inputs:** Each of these eight BNC connectors provides an unbalanced AES input. The monitoring of these signals is determined by the setup menus.
- **3G/HQ/SD-SDI Inputs:** These two BNC connectors input two separate SDI signals. Front panel controls select between the two for monitoring or down converting.

- **3G/HD/SD-SDI Re-Clocked Output:** This BNC connector outputs a re-clocked replica of the selected 3G/HD/SD-SDI input signal.

Getting Started

Once you have connected a 3G/HD/SD SDI video signal to one of the video inputs on the back of the unit, it should display on the video monitor after a few seconds.

Figure 1-3 Video Monitor Display (Left)



To begin any procedure on the AMP1-16V-MD or the AMP1-E16V-MD, powering up the system should display the video input on the left screen, and the audio level meters on the **Main Screen** as shown in [Figure 1-4](#) below.

Figure 1-4 Main Screen (Center and Right)

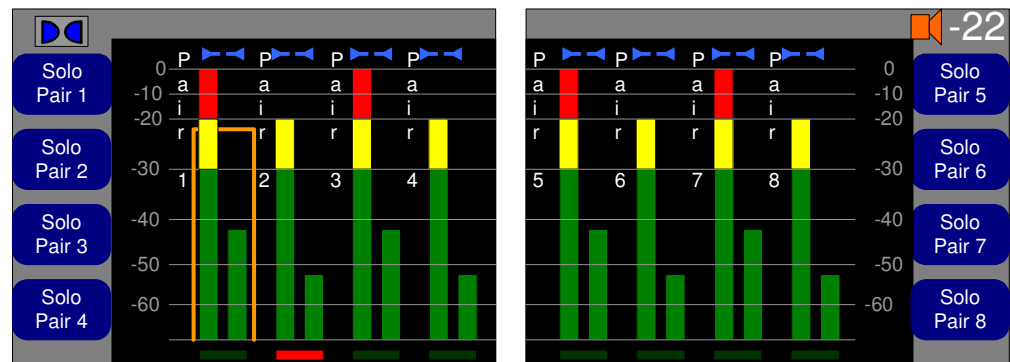

Chapter 1 Quick Start Getting Started

You can launch the menu system by pressing either of the buttons directly below the **Balance** control. These same buttons also either ✓ (**Save and Exit**) or ✕ (**Cancel and Exit**). Context-sensitive, active help appears automatically on the left hand screen for any function.

From the **Main Screen**, press either the ✓ button or the ✕ button to display the **Configuration Selection Menu**. The eight buttons surrounding the screen allow you to access options or functions on the screen or to proceed to other menus.

Note that the **Balance** knob is multifunctional. When the **Main Screen** is displayed, it controls the audio balance, but when any setup menu is displayed, it is used to adjust settings. The actual audio balance does not change while the **Balance** knob is being used for setting up the product.

Generally, to make changes, press the button next to the item you want to change. Then rotate the **Balance** knob to highlight the option that you want and press the **Balance** knob to select it.

Table 1-1 Typical Knob/Button Functionality

Action	Result
Press an option button	Highlights the name of the option
Rotate the Balance knob	Scrolls through the available options
Press the Balance knob	Selects the highlighted option

To move back up in the menu tree, press either the ✓ button (to save) or the ✕ button (to cancel) repeatedly until you reach the **Main Screen**.

Figure 1-5 Configuration Selection Menu

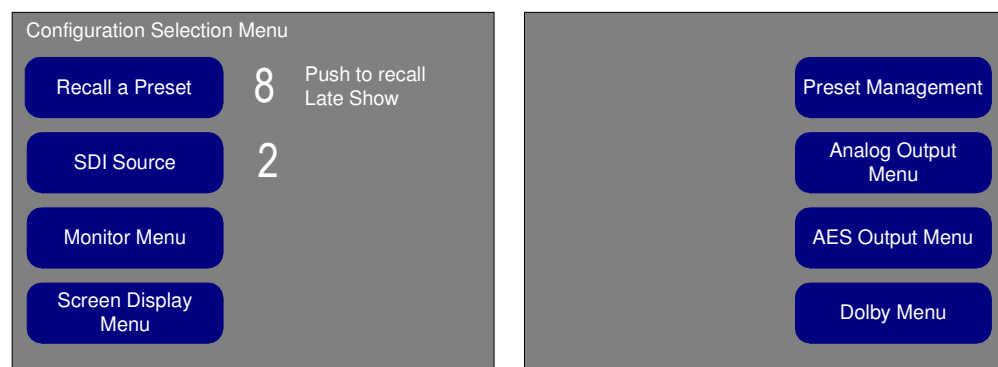

Configuring the System

The functional descriptions fall under the following categories:

- Configuring Audio and Metering ([Chapter 3 on page 35](#))
- Configuring Video and Data ([Chapter 4 on page 47](#))
- Configuring Presets and Hot Keys ([Chapter 5 on page 51](#))

Chapter 1 Quick Start

Configuring the System

CHAPTER 2

The “How Do I...” Chapter

Introduction

Overview

This chapter answers many questions that naturally come up as the AMP1-16V Series monitor is first put into service.

Topics

Topics	Page
Introduction	11
How do I Select the Inputs I Want to Hear in the Speakers?	13
How do I Decode and Monitor a Dolby Bitstream?	14
How do I Decode and Monitor a Dolby Bitstream (Continued)?	15
How do I Cluster Meter Pairs Together for Easy Readability?	16
How do I Customize the Meter Scales?	17
How do I Configure a Hot Key to Solo a Cluster?	18
How do I Configure a Hot Key to Mute a Cluster?	19
How do I Configure the AES and Analog Outputs?	21
How do I Set Up for External Surround Sound?	23
How Do I Sync Internal Speaker Audio with an External Video Monitor?	24
How Do I Use Presets to Change Inputs?	25
How do I Display the Loudness of a Cluster of Channels?	27
How do I Display Dolby Metadata instead of Video?	29
How do I Display Dolby Metadata Along With Video?	30

Topics	Page
How Do I Terminate or Untermine AES Inputs?	32
How do I Find Software Version Information?	33

Notation

In this chapter, we use a shorthand method to show you how to progress from the Main Screen to the menus. Refer to [Figure 2-1](#) below.

Figure 2-1 Screen Notation

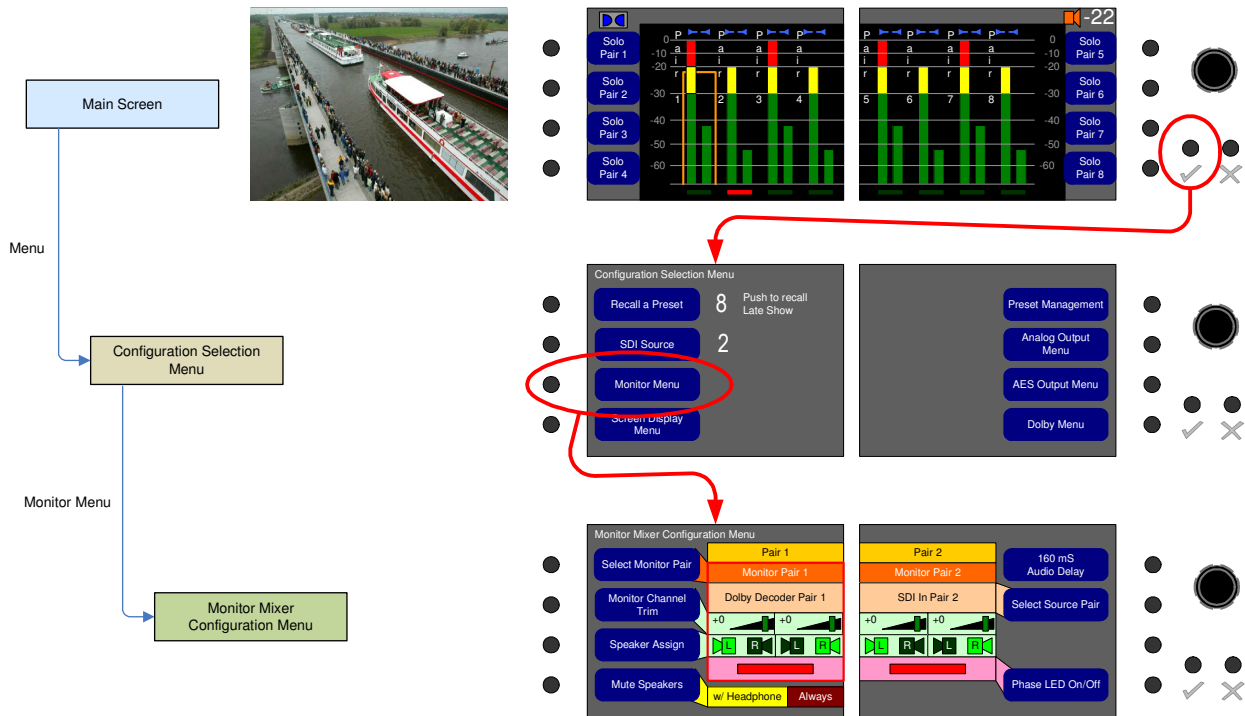

Or simply

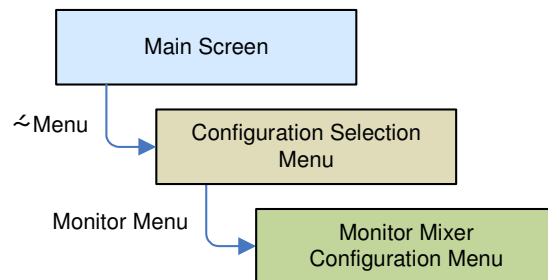

Frequently Asked Questions

For all of the following instructions, **Active Help** displays on the left screen.

How do I Select the Inputs I Want to Hear in the Speakers?

The AMP1-16V-MD offers a wide variety of inputs. You may monitor any 16 of the input channels, in any mix, on the meters and through the speakers. Assigning inputs to be monitored is done in the **Monitor Mixer Configuration Menu**:

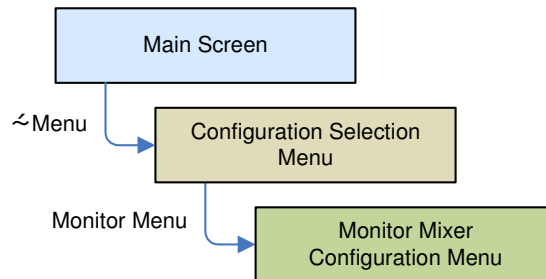

1. Press the **Select Monitor Pair** control and then turn the **Balance** knob to select the channel pair on which you want the input to be monitored. Note that the channel pairs scroll right and left as you turn the **Balance** knob so that you can select any one of the eight channel pairs.
2. Press the **Select Source Pair** control and then turn the **Balance** knob to select the input. Refer to the **AES In Pair 1** in [Figure 2-2](#) below.

Figure 2-2 Monitor Mixer Configuration Menu

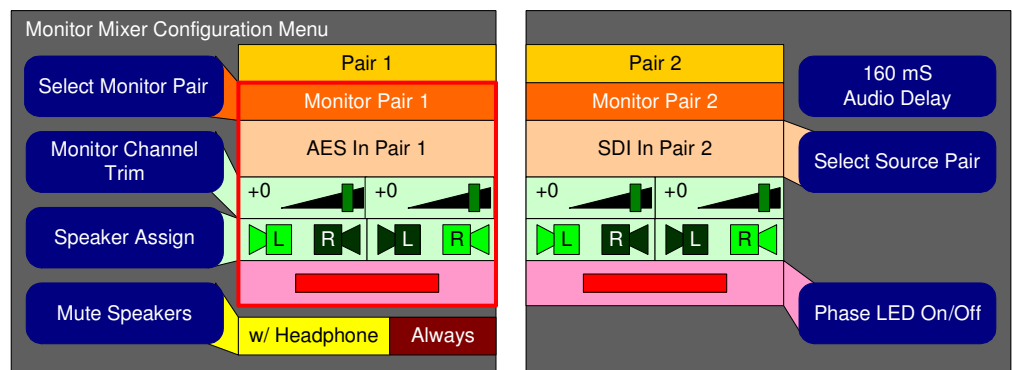

3. Repeat Steps 1 and 2 for each input to be monitored.

How do I Decode and Monitor a Dolby Bitstream?

You can continuously monitor a single Dolby bitstream from the SDI or AES inputs even if the bitstream itself doesn't appear on the **Main Screen** meters. You can also continuously monitor the Dolby metadata.

Note: The AMP1-E16V-MD must contain the optional Dolby decoder card in order to decode a Dolby bitstream.

Setting up continuous Dolby bitstream monitoring is a two-step process, first set up the Decoder card and then set up the monitoring channels. The first step involves configuring the Dolby decoder card:

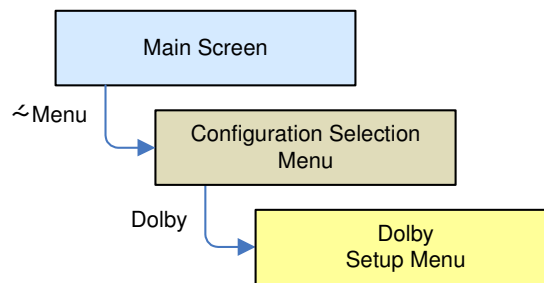

1. Press the **Decoder Source** control button and then turn the **Balance** knob to the AES or SDI channel pair that contains the Dolby bitstream to be decoded.

Figure 2–3 Dolby Setup Menu

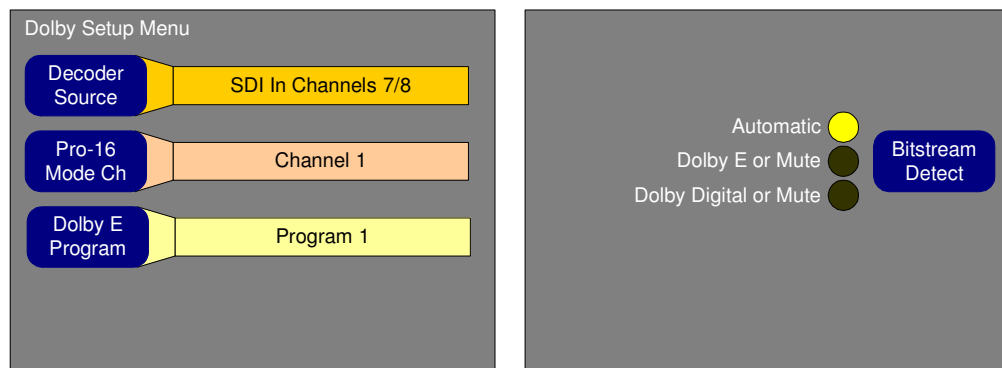

2. Follow the instructions on the next page to select the meter channels on which you would like to view the decoded channels.

How do I Decode and Monitor a Dolby Bitstream (Continued)?

Now that you have connected a Dolby bitstream source to the Dolby decoder, you need to connect the outputs of the Dolby decoder to the metering channels you will be monitoring the audio on.

This step involves configuring the **Monitor Mixer Configuration Menu**:

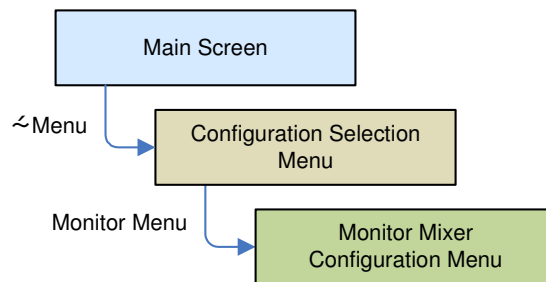

1. Press the **Select Monitor Pair** control and then turn the **Balance** knob to select the channel pair that you want the first decoded Dolby pair to reside on. Note that the channel pairs scroll right and left as you turn the **Balance** knob so that you can select any one of the eight channel pairs.
2. Press the **Select Source Pair** control and then turn the **Balance** knob to select the decoded Dolby pair, as shown outlined in a red box below.

Figure 2–4 Monitor Mixer Configuration Menu

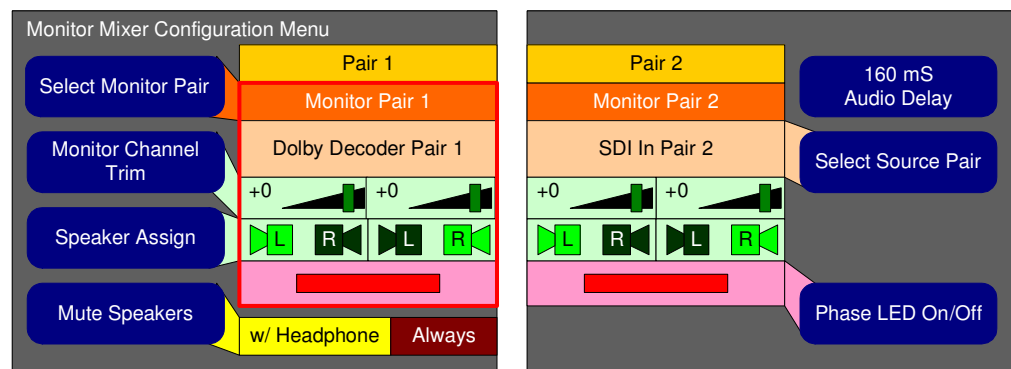

3. Repeat Steps 1 and 2 for each decoded pair.

Chapter 2 The “How Do I...” Chapter Frequently Asked Questions

4. For the Center and LFE channels, press the **Speaker Assign** knob and then turn the **Balance** knob to select the dark **R** and **L** icons and then press the **Balance** control to light them as shown in the following figure. Then you will hear the Center and LFE channels in both speakers.
5. Refer to the following section to cluster the 5.1 meter bars together.

How do I Cluster Meter Pairs Together for Easy Readability?

Clustering the meter pairs in logical arrangements enhances the at-a-glance readability of the meters. After setting up the meter clusters, you can set up hot keys to solo each cluster. You can cluster the meters together from the **Cluster Configuration Screen**:

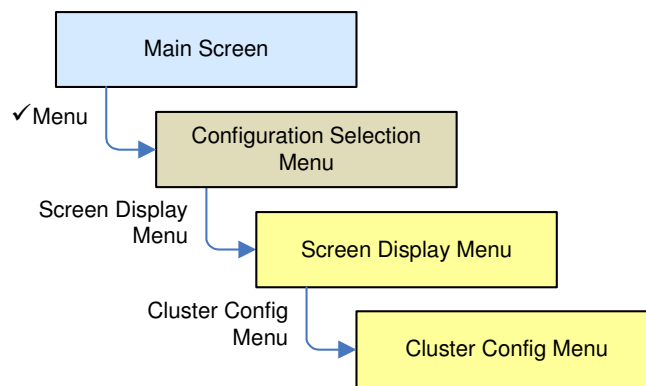

1. Press the **Select Cluster** knob and then turn the **Balance** knob to select the channel pair that you want the cluster to start on. Note that the blue bracket at the top selects.
2. Press the **Cluster End** control and then turn the **Balance** knob so that the blue bracket encompasses the channel pairs you want in the cluster. Press the **Balance** knob to set the cluster and see the new arrangement.
3. Press the **Edit Cluster Label** knob to proceed to a screen that lets you name the cluster. This name will appear on the **Main Screen**.

Figure 2–5 Cluster Configuration Menu

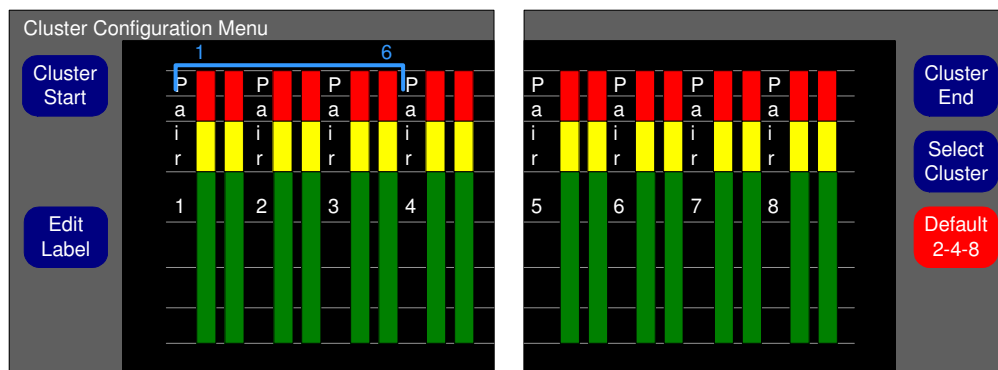

4. Press the **Edit Cluster Label** knob to proceed to a screen that lets you name the cluster. This name will appear on the **Main Screen**.
5. Refer to the following section to set up a hot key that will solo the whole cluster.

How do I Customize the Meter Scales?

The AMP1-16V-MD contains a number of commonly-used meter scales.

You can set the meter scale in the **Meter Configuration Menu**:

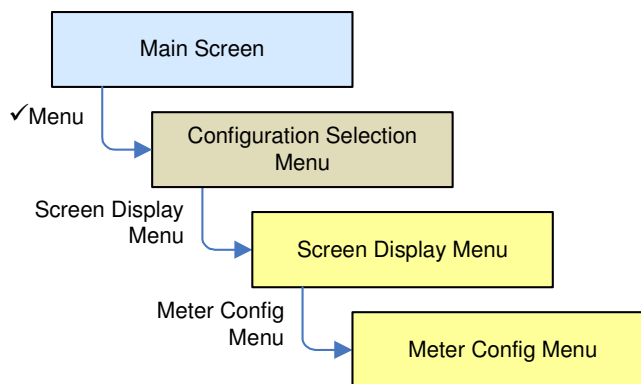

1. Press the Scale control and then turn the **Balance** knob to select your choice of meter scale.
2. If you want to change the ballistics, press the **Ballistics** knob and then turn the **Balance** knob to select your new choice.

Chapter 2 The “How Do I...” Chapter
Frequently Asked Questions

3. If you would like to adjust the color-to-color transition points of the meter segments, use the **Upper Segment**, **Middle Segment**, and **Lower Segment** knobs. Pressing each control and then turning the **Balance** knob, selects the color of the segment. Pressing the **Balance** knob and then turning it will adjust the transition point.

Figure 2–6 Meter Configuration Menu

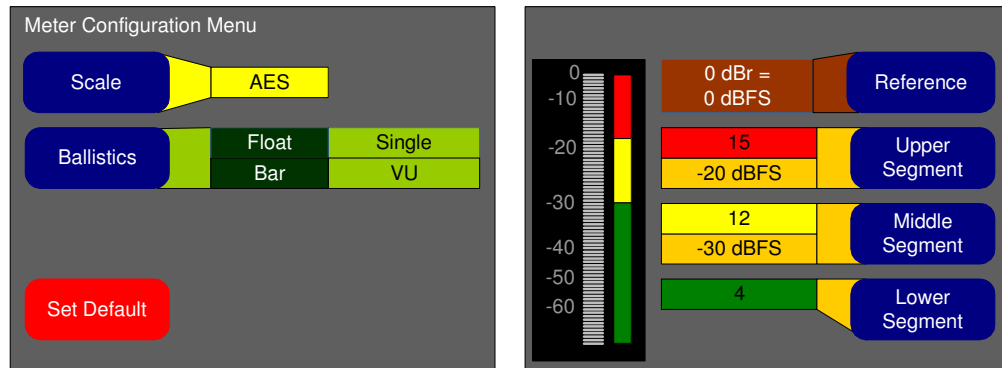

How do I Configure a Hot Key to Solo a Cluster?

By default each pair is a two-channel cluster and a hot key is set up for each. But when other clusters are configured, such as a 5.1 channel Dolby cluster, it makes sense to set up a **Solo** hot key for that.

Setting up **Solo** hot keys is done in the **Main Screen Hot Key Configuration Menu**:

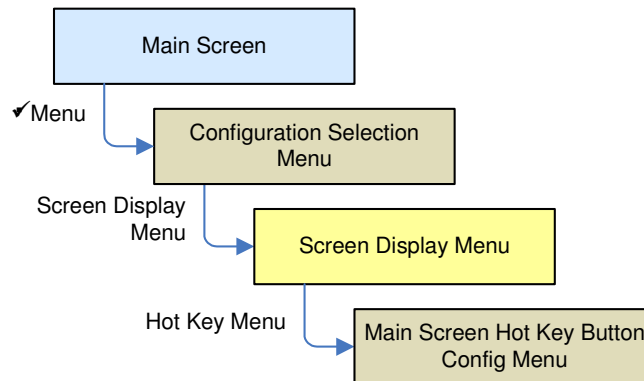

1. Press the button corresponding to the **Solo** hot key to be set up.
2. Turn the **Balance** knob to the type of hot key, and press the **Balance** knob until **Solo** is selected and the control turns blue.

- Turning the **Balance** knob again will let you highlight each channel in order. Pressing the **Balance** knob lets you lighten or darken each channel. Lighten each channel that you want as part of the **Solo** and darken the others, as shown Figure 2-7 below.

Figure 2-7 Main Screen Hot Key Button Configuration Menu

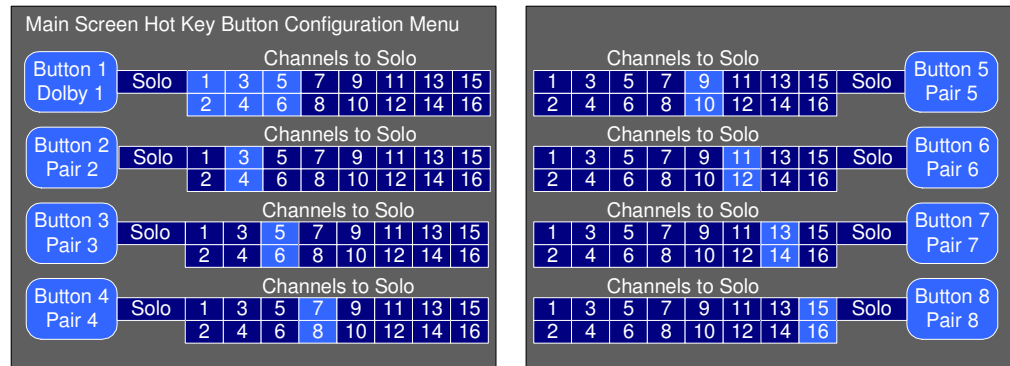

- You can name the **Solo** hot key by turning the **Balance** knob to highlight the **Solo** label itself and then pressing the **Balance** knob. This will proceed to the text labeling menu.

How do I Configure a Hot Key to Mute a Cluster?

Solo hot keys are part of the default configuration of the AMP1-16V-MD. Sometimes it is convenient to also have some **Mute** controls as well. You can set this up in the **Main Screen Hot Key Button Configuration Menu**:

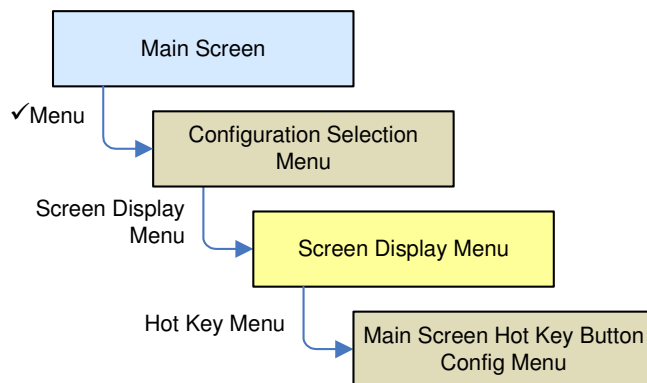

- Press the hot key you want to be used to become a **Mute** button. Turn the **Balance** knob to highlight the type of hot key, and then

Chapter 2 The “How Do I...” Chapter Frequently Asked Questions

press the **Balance** knob repeatedly until **Mute** is selected and the control turns red.

2. Turn the **Balance** knob again to highlight the number of the first channel you want to mute. Press the **Balance** knob to light up your choice.
3. Repeat Step 3 until you have lit up all of the channels you want this control to mute.
4. You can name the new hot key by turning the **Balance** knob to highlight the button label itself and then pressing the **Balance** knob. The hot key naming screen will then appear to allow you to name the preset. Enter a name that is descriptive and that you will recognize later.

Now, on the **Main Screen**, that same control will mute the channels you selected.

Figure 2–8 Main Screen Hot Key Button Configuration Menu

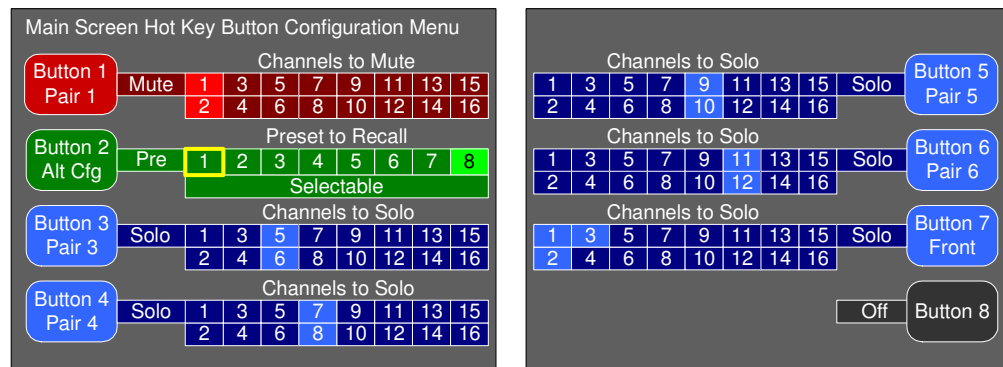

5. You can name the **Mute** hot key by turning the **Balance** knob to highlight the **Mute** label itself and then pressing the **Balance** knob. This will proceed to the text labeling menu.

How do I Configure the AES and Analog Outputs?

You can use the AES and analog output ports to output selected signals from the inputs: from the optional Dolby decoder, from the monitor mix, or from the single monitor pair mixed to the speakers.

The **AES** and **Analog Output** menus are very similar. To configure one of them go to the **AES Output Menu** or **Analog Output Menu** as shown:

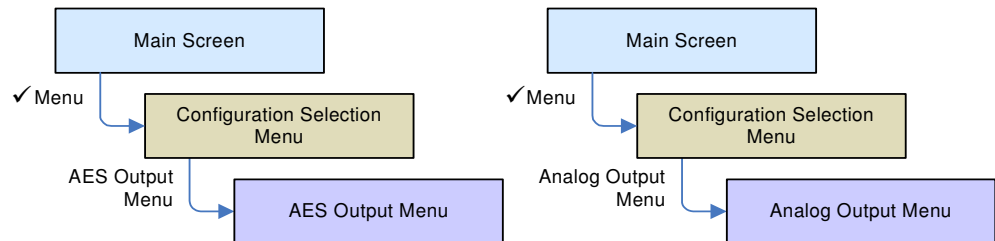

There are two output modes: **Selected Sources** or **Monitor Channels**. Press the upper left **Output =** button. Then toggle between these two modes by pressing the **Balance** knob. In the example below, we show the **AES Output Configuration Menu**, but the steps equally apply to the **Analog Output Configuration Menu**.

Figure 2–9 AES Output Configuration Menu in Selected Sources Mode

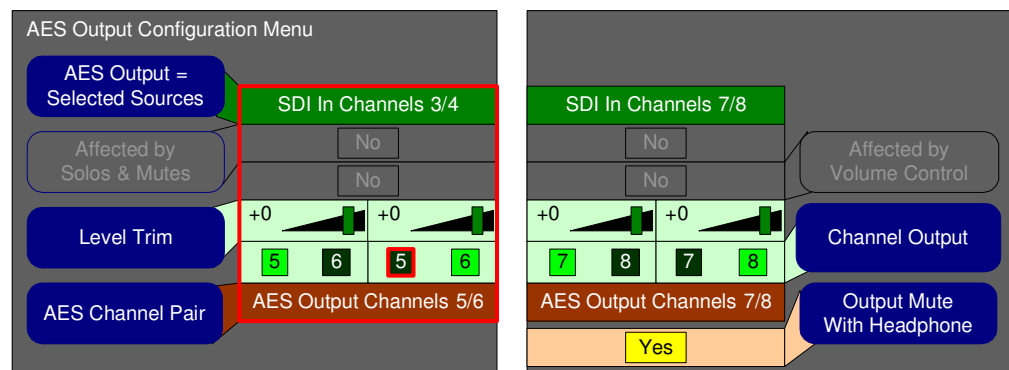

1. Press the **Channel Pair** button. Note that the channel pairs scroll right and left as you turn the **Balance** knob so that you can select any one of the eight AES channel pairs (or four analog channel pairs).

Chapter 2 The “How Do I...” Chapter Frequently Asked Questions

2. Press the **Output = Selected Sources** button and turn the **Balance** knob to select any of the SDI channel pairs, the Dolby channel pairs, or the monitor mix channel pair.
3. Using the **Level Trim** and **Channel Output** buttons, you can adjust what channels and signal level will be output.
4. Repeat Steps 1 through 3 for each of the output channel pairs as needed.

Figure 2–10 AES Output Configuration Menu in Monitor Channels Mode

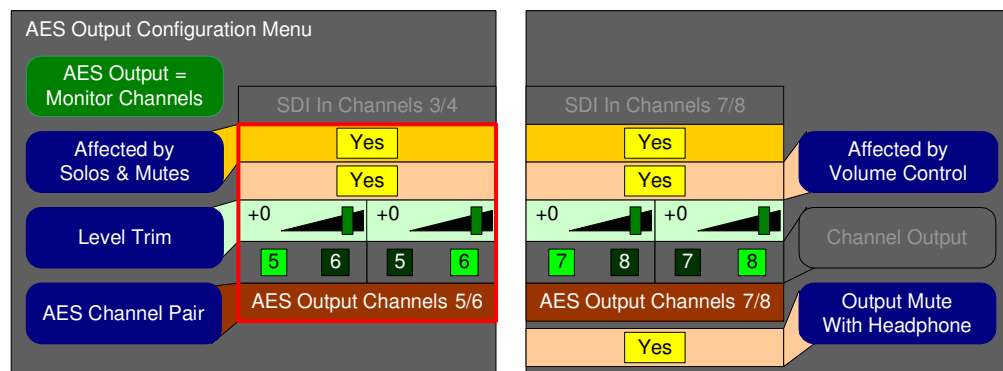

5. Press the **Channel Pair** button. Note that the channel pairs scroll right and left as you turn the **Balance** knob so that you can select any one of the eight channel pairs (or 4 analog channel pairs).
6. Press the **Affected by Solos & Mutes** button to toggle whether each output channel pair can be controlled by the **Solo** and **Mute** hot keys.
7. Press the **Affected by Volume Control** button to toggle whether each output will be affected by the **Volume** and **Balance** controls.
8. Repeat steps 5 - 7 for each of the output channel pairs needed.

How do I Set Up for External Surround Sound?

If a studio or other monitoring environment contains a surround sound system, it may be advantageous to connect the monitored sound from the AMP1-16V-MD monitor to this system. Up to four pairs (eight channels) of AES or analog outputs are available for this use. After connecting the needed AES or analog outputs to your surround sound system, you will need to set up the AMP1-16V-MD to provide the channels you need.

This is done in the **AES Output Menu** or **Analog Output Menu** as shown:

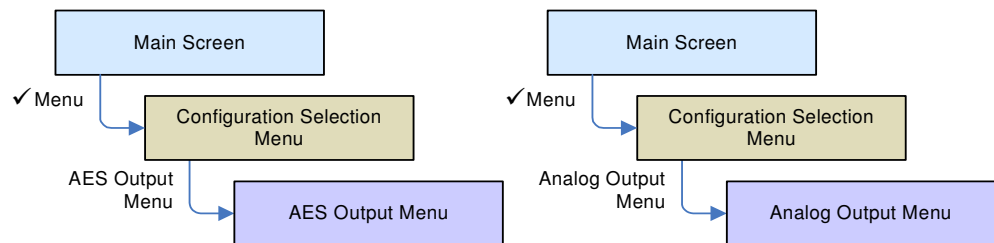

1. Press the upper left **Output =** selector button. Then press the Balance knob to select **AES (or Analog) Output = Monitor Channels**.
2. Press the **Channel Pair** button. Note that the channel pairs scroll right and left as you turn the Balance knob so that you can select any one of the channel pairs.
3. Press the **Affected by Solos & Mutes** button to select **Yes** so that the output channel pair can be controlled by the **Solo** and **Mute** hot keys.
4. Press the **Affected by Volume Control** button to select **Yes** so that the output channel pair can be controlled by the **Volume** and **Balance** controls.
5. Repeat Steps 2 through 4 for each of the output channel pairs needed.

How Do I Sync Internal Speaker Audio with an External Video Monitor?

Audio from all input sources can be delayed before it gets to the internal speakers by up to 170 ms. Typically, this can be done to compensate for video processing delays a video monitor that may be used in conjunction with the AMP1-16V-MD. Adjust the **Main Screen** controls so that you are viewing the video and hearing the associated audio. Then adjust the **Audio Delay** in 1 ms increments in the **Monitor Mixer Configuration Menu**.

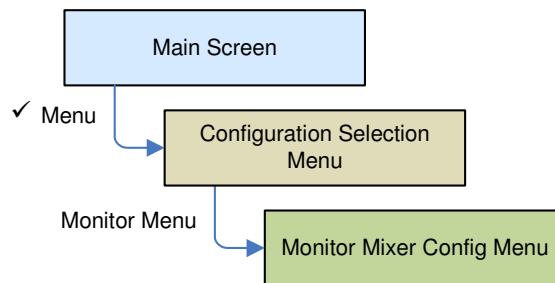

1. Press the **Audio Delay** button.
2. Turn the **Balance** knob while listening to the audio and watching the video. Adjust until that they appear to be synchronized.
3. The **Audio Delay** control will then show you how much delay it needed to add.
4. If you need to set a specific delay, you can of course do that by simply adjusting the **Audio Delay** control to that amount.

Figure 2–11 Monitor Mixer Configuration Menu

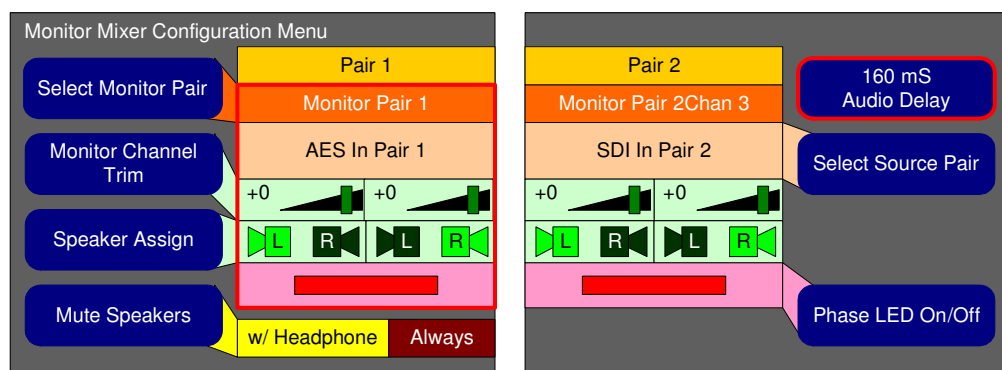

How Do I Use Presets to Change Inputs?

The AMP1-16V-MD has more inputs than can be monitored on a 16-channel screen. The AMP1-16V-MD has the ability to store eight entire system configurations as presets, including the inputs that are being monitored. Any of these presets can be instantly recalled from the **Main Screen** as needed.

Suppose you need to monitor an SDI stream sometimes, but other times you need to monitor just some of those SDI channels along with some AES or analog channels. You could set up one preset configuration to monitor purely the SDI stream channels, and another to monitor the mix of channels you sometimes need. If there are other input sources you sometimes need to monitor, you could set up preset system configurations for each scenario, up to a total of eight presets.

Using the other menus, first set up all of the parameters that are to be part of the preset. Then use the **Preset Management Menu**:

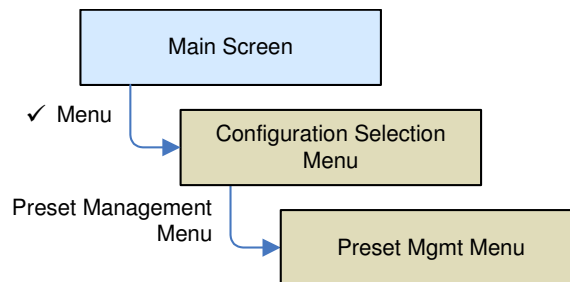

1. Press the **Save Current Configuration** button and then turn the **Balance** knob to select the number (1 to 8) of the preset you would like to save the current configuration into. Then press the **Balance** knob.

Figure 2–12 Monitor Mixer Configuration Menu

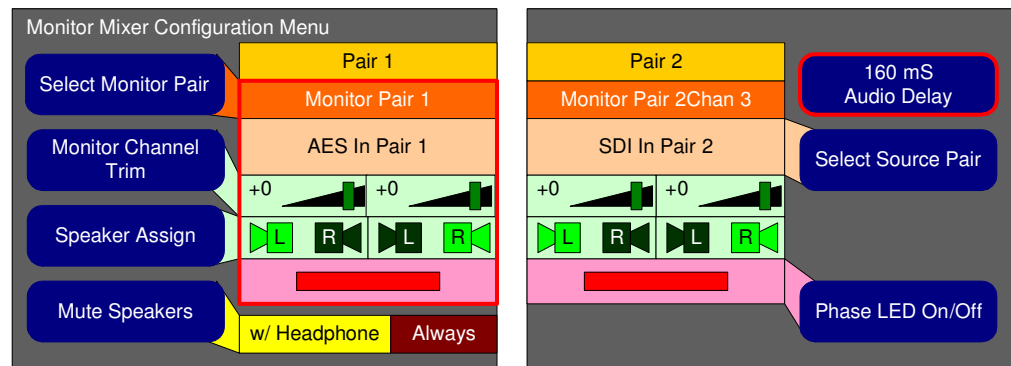

Chapter 2 The “How Do I...” Chapter Frequently Asked Questions

2. The preset naming screen will automatically appear to allow you to name the preset. Enter a name that is descriptive and that you will recognize later. If you have named this preset before and want to keep the same name, simply press ✓ to save and exit the naming screen.
3. Next, using the other menus, set up another input channel arrangement. Then return to the **Preset Management Menu** to repeat the above steps.

How Do I Quickly Recall Presets from the Main Screen?

While presets can always be recalled from the **Recall Preset** control on the **Configuration Selection Menu**, pressing **Recall Preset** hot keys on the **Main Screen** is an even more direct and quick way to do it. This is set up in the **Hot Key Configuration Menu**:

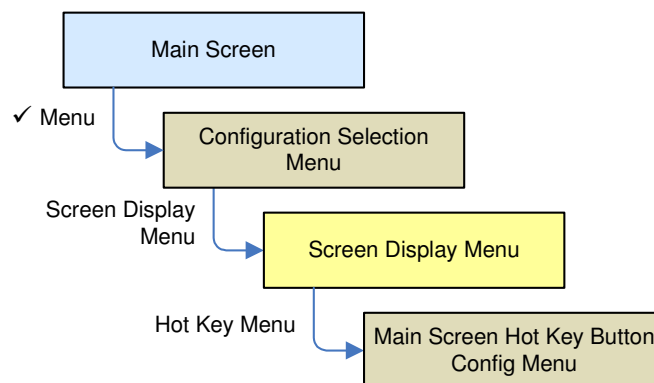

1. Press the hot key that you want to be used to quickly recall a preset. Turn the **Balance** knob to highlight the type of hot key, and then press the **Balance** knob repeatedly until “**Pre**” is selected and the control turns green.
2. Turn the **Balance** knob again to highlight the number of the preset you want the hot key to recall. You may also set it to **Selectable**.
3. Press the **Balance** knob to light up your choice.
4. You can name the new hot key by turning the **Balance** knob to highlight the button label itself and then pressing the **Balance** knob. The hot key naming screen will then appear to allow you to

name the preset. Enter a name that is descriptive and that you will recognize later.

Now, on the **Main Screen**, that same control will recall a preset.

Figure 2–13 Main Screen Hot Key Button Configuration Menu

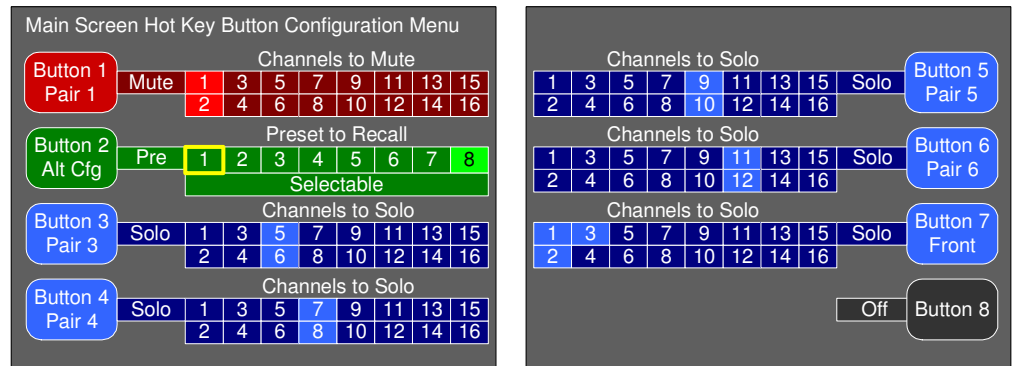

How do I Display the Loudness of a Cluster of Channels?

The loudness in LKFS units of any one channel cluster can be displayed in the upper right corner of the **Main Screen**. Choosing the cluster and configuring it for the loudness measurement is done in the **Loudness Configuration Menu**. This configuration is also saved as part of each **Preset**, along with the channels that are to be monitored. Set up the channel clusters using the **Monitor Menu** before setting up the loudness measurement.

The **Loudness Configuration Menu**:

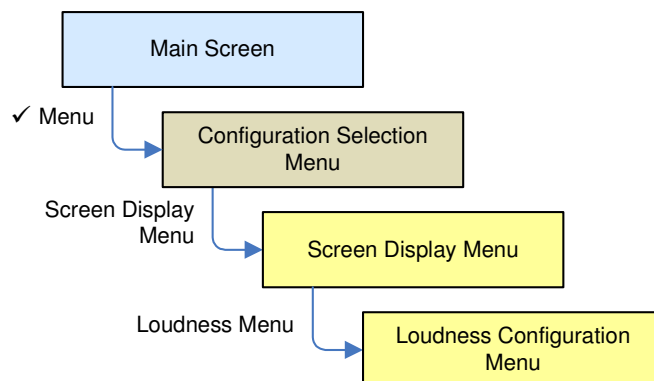

Chapter 2 The “How Do I...” Chapter Frequently Asked Questions

1. Press the **Loudness Mode** button to change from **Off** to **Program**.
2. Press the **Cluster Select** button and turn the **Balance** knob to select the cluster to be measured.
3. Press the **Channel Select** button and turn the **Balance** knob to select a channel.
4. Press the **Loudness Contribution** button and turn the **Balance** knob to identify the correct function of the channel and then press the **Balance** knob to light the selection. For a cluster consisting of simply a stereo channel pair, select **Front**. For a Dolby 5.1 cluster, select **Front**, **Center**, **Rear**, or **None** as appropriate. The LFE channel should be set to **None**.
5. Repeat Steps 2 through 4 until you have configured each channel.
6. Press the **Loudness Window** button and turn the **Balance** knob to select the desired loudness window. Three seconds is the default.

Figure 2–14 Loudness Configuration Menu

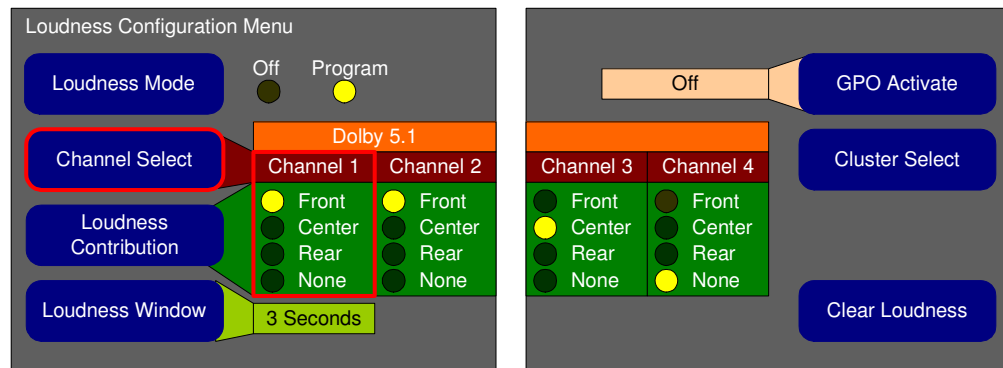

How do I Display Dolby Metadata instead of Video?

The left screen can be used to display either video from the SDI signal or up to eight lines of Dolby metadata. Displaying Dolby metadata can be useful loudness in situations where observing video is secondary. The selection between video and metadata is done in the **Screen Information Setup Menu**.

The **Screen Information Setup Menu**:

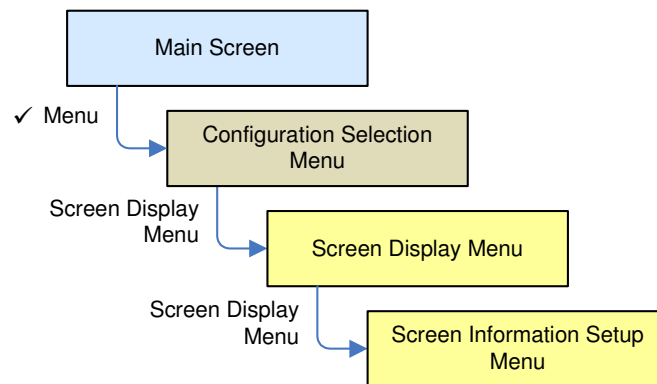

1. To change the left screen from displaying video to displaying Dolby metadata, press the **Format** button to light the **Data** indicator.
2. Press the **Left Screen** button.
3. Press the **Displayed Data** button and turn the **Balance** knob to highlight a Dolby metadata item to be monitored. Then press the **Balance** knob to select it.
4. Repeat Step 3 for each Dolby metadata item to be displayed, up to a total of eight.
5. Press the **Data Text Color** button and turn the **Balance** knob to select the color of the text to be displayed.
6. Press the **Data Field Color** button and turn the **Balance** knob to select the color of the background of the text to be displayed.

Figure 2–15 Screen Information Setup Menu

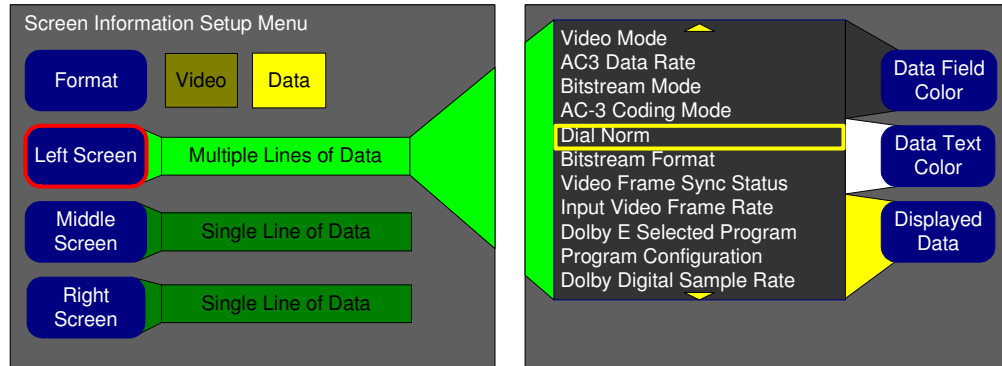

How do I Display Dolby Metadata Along With Video?

Two lines of Dolby metadata can be displayed on the meter screens, one on each screen. The selection of which lines to display is done in the **Screen Information Setup Menu**.

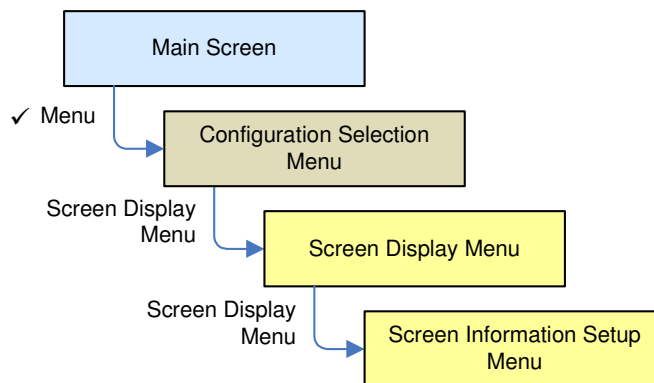

1. Press the **Middle Screen** button to select the Dolby metadata to be shown on the middle meter screen.
2. Press the **Displayed Data** button and turn the **Balance** knob to highlight a Dolby metadata item to be monitored. Then press the **Balance** knob to select it. Only one item may be selected.
3. Press the **Data Text Color** button and turn the **Balance** knob to select the color of the text to be displayed.
4. Press the **Data Field Color** button and turn the **Balance** knob to select the color of the background of the text to be displayed.
5. Press the **Right Screen** button and repeat Steps 2 through 4 to select the Dolby metadata to be shown on the right meter screen.

Figure 2-16 Screen Information Setup Menu

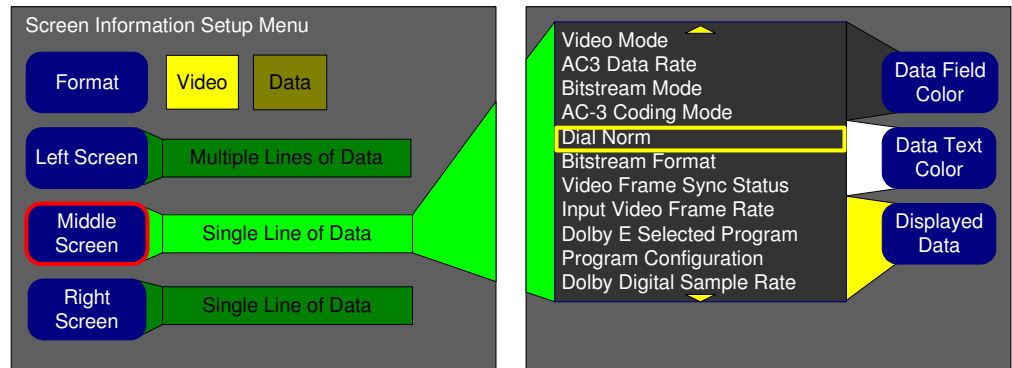

How do I Adjust the Screen Saver or Screen Brightness?

The **Screen Saver** can prolong the life of the displays. By default, it is set to eight hours, which means that after eight hours of inactivity the screens will dim, and then after another eight hours the screens will dim to a lower level. The screens will not actually turn off and are still functional while dimmed. Turning or pressing any control, including the **Volume** control, brightens the screens and restarts the **Screen Saver** timeout. The **Screen Saver** time is adjustable between five minutes and 24 hours, or it may be turned off.

The brightness of each screen may be adjusted individually to suite the studio environment. It may be that one brightness setting may be optimum for the video screen, while a different brightness setting may work better for the metering screens. Thirty-two distinct brightness levels can be selected.

You can make these adjustments in the **Hardware Configuration Menu**:

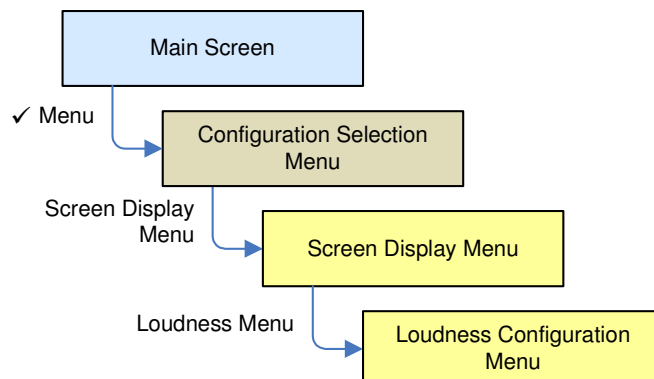

Chapter 2 The “How Do I...” Chapter Frequently Asked Questions

1. Press the **Screen Saver** button and then turn the **Balance** knob to adjust the screen saver timeout or to turn it off.
2. Press the **Screen Bright** button repeatedly to select which screen to adjust. The selected adjustment is shown by a blinking indicator. Turn the **Balance** knob to adjust the brightness. The brightness of each screen will change as you adjust it. The default level is 22.

Figure 2–17 Hardware Configuration Menu

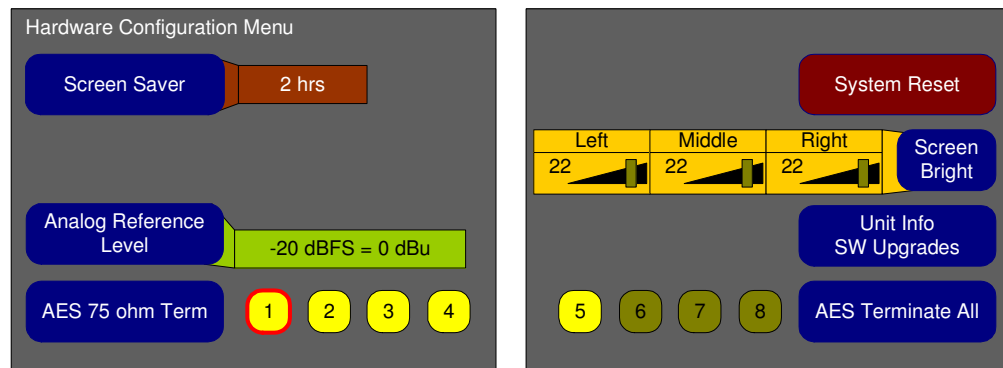

How Do I Terminate or Untermine AES Inputs?

AES signals should have one and only one termination. This termination should physically be located at the last destination of an AES coax cable. If the AMP1-16V-MD is the last connection in a series of AES connection, then its terminations should be turned on. By default, the AES inputs of the AMP1-16V-MD are all terminated.

A symptom of too many terminations (or no termination) is that no signal appears to be present on the AES input. You can make these adjustments in the **Hardware Configuration Menu**:

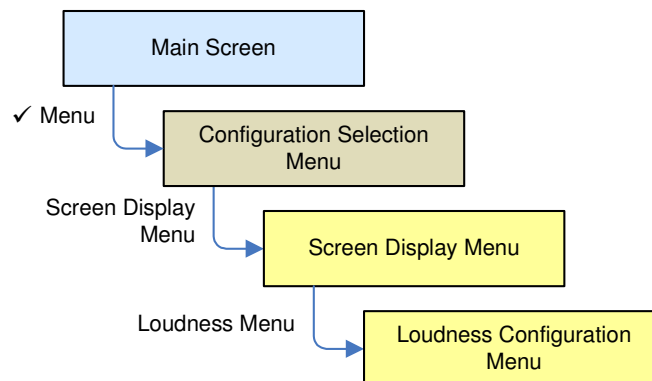

1. To terminate or unterminate all of the AES input pairs on the card in this slot, press **AES Terminate All**. This is an alternate-action button.
2. To terminate or unterminate one AES input pair, press the **AES 75 ohm Term** button and then turn the **Balance** control to select the pair that you want to terminate or unterminate. Press the **Balance** control light (terminate) or darken (unterminate) your selected pair. This is an alternate-action button.

Figure 2–18 Hardware Configuration Menu

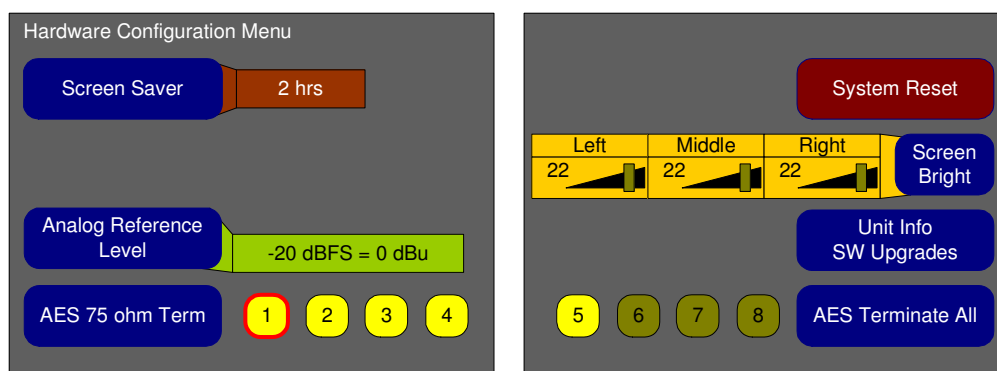

How do I Find Software Version Information?

Occasionally, when speaking with a customer service representative, it is necessary to locate the software versions of the software in the AMP1-16V-MD.

The **Unit Information Screen**:

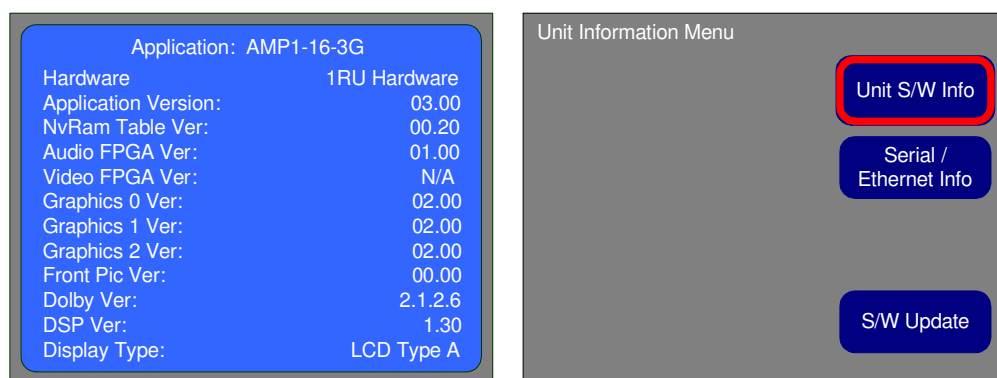

The left screen contains the version numbers of the system software.

CHAPTER 3

Audio and Metering

Introduction

Overview

The AMP1-16 Series monitors are primarily designed to monitor audio and video. Configuration options include specifying channels to monitor, phase indicators, setting audio delay, and individual channel volume controls.

Topics

Topics	Page
Introduction	35
Configuration Options	36
Configuring the Audio Outputs	36
Level Metering	44

Configuration Options

The AMP1-16 Series monitors are very flexible and can be configured to adapt to almost any audio configuration. The available adjustments are:

- Selecting the inputs (signal sources) to monitor
- Trimming the volume of each channel
- Indicating the phase relationship of each channel pair
- Muting the audio output of the speakers
- Selecting the signal sources for the AES and analog rear panel outputs
- Selecting the **Monitor Downmix**
- Setting the audio delay for video synchronization

Configuring the Audio Outputs

Overview

You can route the digital audio signals at the inputs of the AMP1-16V-MD Series monitors to the front panel speakers or to the outputs, depending on your needs. The internal routing paths are controlled by the settings in the setup menus. The following diagram ([Figure 3-1](#)) shows the relationship between the internal routing paths and the various menus that control the signal flow.

The colors in this diagram represent various audio formats or levels of processing. Each menu will select, route, or adjust the audio paths. Further detail on each of these menus is available in [Chapter 6: Menu List on page 65](#).

Note that you can set up multiple audio paths. For example, while monitoring de-embedded SDI audio channels through the speakers, you may independently decode Dolby channels from an AES stream, convert them to analog, and output them. Setups like this can be stored

as presets and recalled later. See [Chapter 5: Efficiency Enhancements](#) on page 51.

Figure 3-1 Audio Routing Diagram

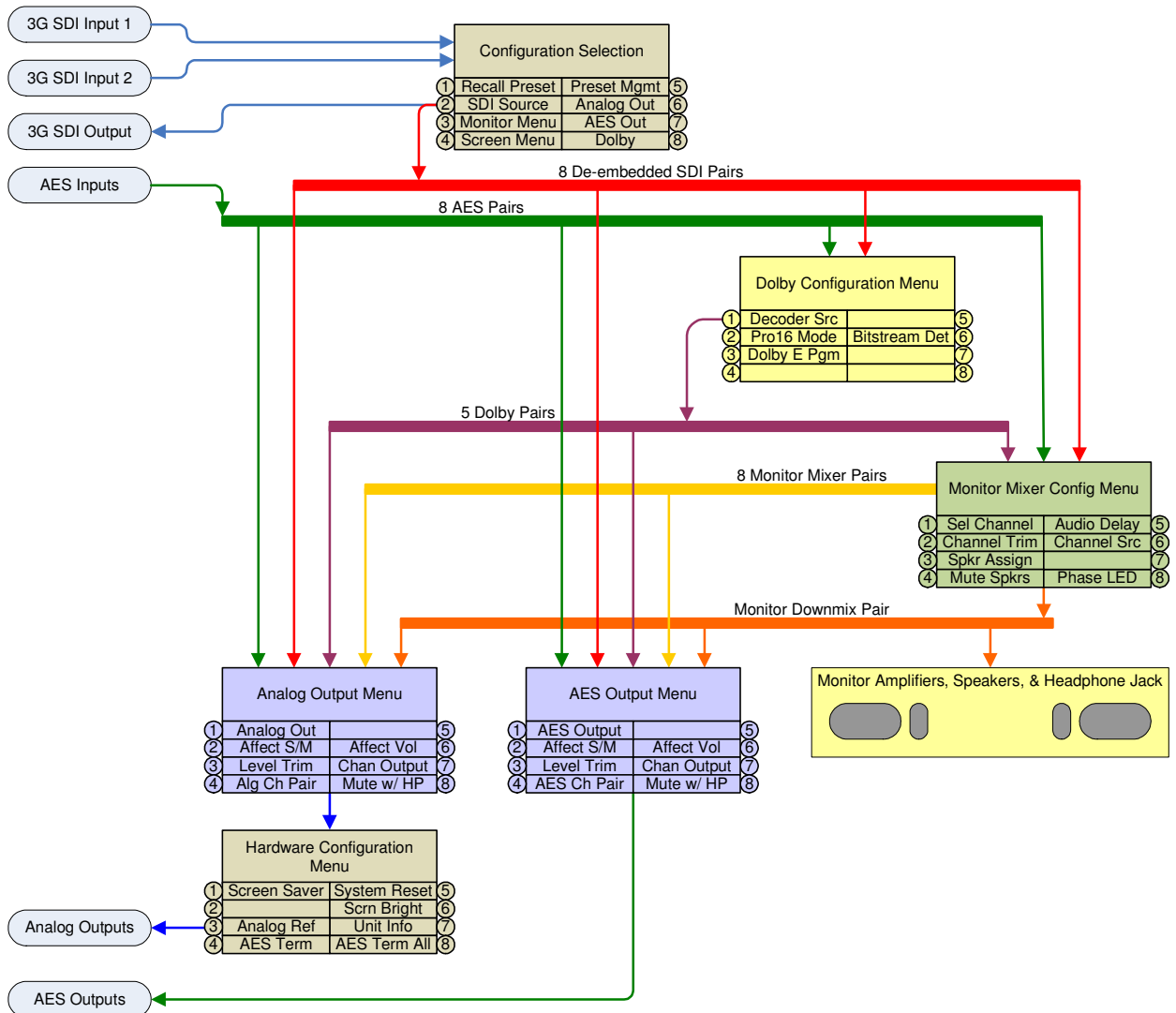

Surround Sound

If a studio or other monitoring environment contains a surround sound system, it may be advantageous to connect the monitored sound from the AMP1-16 Series monitor to this system. Up to eight pairs (16 channels) of AES outputs or four pairs (eight channels) of analog outputs are available for this use. The front panel **Volume**, **Balance**, and solo, and mute controls will then optionally affect the surround sound. You can easily configure this in the **AES Output** and the **Analog Output Configuration Menus** as described below.

Chapter 3 Audio and Metering

Configuring the Audio Outputs

1. From the **Main Screen**, press either the ✓ button or the X button to display the **Configuration Menu**.
2. From the **Configuration Menu**, select either the **AES Output Configuration Menu** or the **Analog Output Configuration Menu** depending on the output type you want to use. In our example, we're using the **AES Output Configuration Menu**.
3. If needed, press the **AES Output = Selected Sources** button and then press the **Balance** knob to display **AES Output = Monitor Channels**. This will set the outputs so that they match those viewed on the meters in the **Main Screen**.

Figure 3–2 AES Output = Monitor Channels

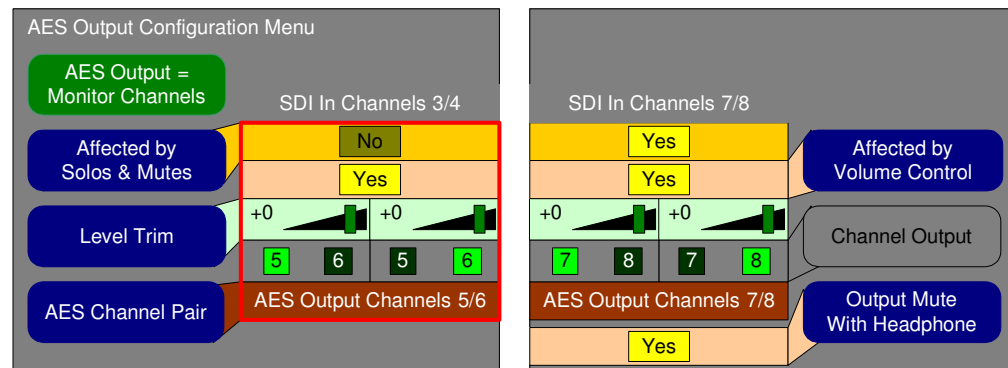

4. You can also specify whether the outputs should be affected by:
 - A. The **Solo** and **Mute** hot keys (available per channel pair), by pressing the **Affected by Solos and Mutes** button.
 - B. The front panel **Volume** control (available per channel pair), by pressing the **Affected by Volume Control** button.
 - C. Inserting a pair of headphones to mute the output audio channels (available system-wide), by pressing the **Output Mute with Headphone** button.

Stereo Downmix

If a studio or other monitoring environment contains a stereo sound system, it may be advantageous to connect the monitored sound from the AMP1-16 Series monitor to this system. One or more of the AES or

analog output pairs are available for this purpose. The front panel **Volume**, **Balance**, and solo controls will then affect the stereo downmix output sound. You can easily configure a stereo downmix in the **AES Output Menu** and the **Analog Output Menu**. Note that the stereo downmix will also be affected by the trim, speaker assign, and delay in the **Monitor Mixer Configuration Menu**, and also by the trim, channel output, and mute with headphone settings in the **AES Output Menu/Analog Output Menu**.

The **Monitor Downmix** pair is one of the sources listed on the **AES Output Configuration Menu** and the **Analog Output Configuration Menu**. Configure either menu as follows.

1. From the **Main Screen**, press either the ✓ button or the X button to display the **Configuration Menu**.
2. From the **Configuration Menu**, select either the **AES Output Configuration Menu** or the **Analog Output Configuration Menu** depending on the output type you want to use. In our example, we're using the **AES Output Configuration Menu**.
3. If needed, press the **AES Output = Monitor Channels** button and then press the **Balance** knob to display **AES Output = Selected Sources**.

See [Figure 3-3 on page 39](#). In our example, the **AES Output Configuration Menu** displayed with **AES Output = Selected Sources** so we didn't need to change that. But it did display "matching" inputs (5 and 6) and outputs (5 and 6). We'll modify this in the next step.

Figure 3-3 Select AES Output = Selected Sources

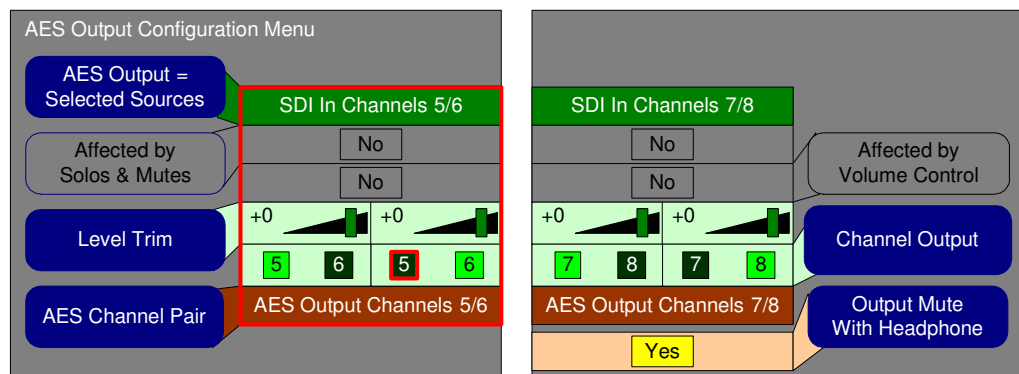

Chapter 3 Audio and Metering
Configuring the Audio Outputs

- Next, press the **AES Channel Pair** button and then rotate the **Balance** knob to select the AES pair that will receive the **Monitor Downmix**. In our example in [Figure 3-4](#) below, we selected Channel Pair 1/2.

Figure 3-4 Select Outputs

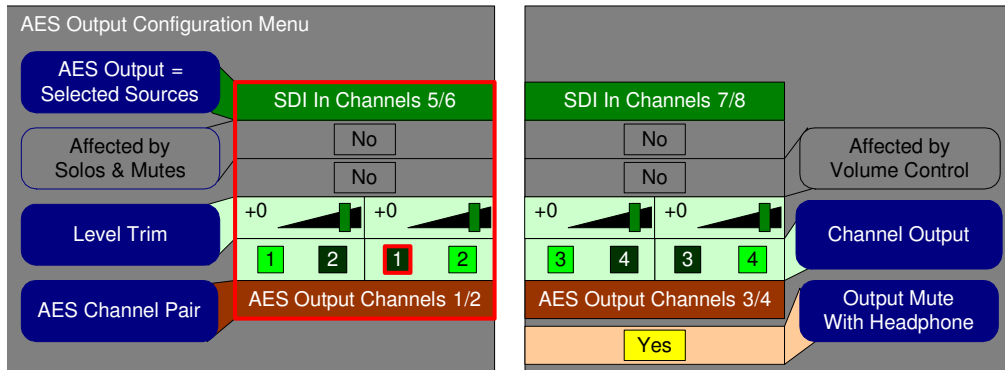

- When the outputs you want are highlighted, press the **AES Output = Source Select** button again and then rotate the **Balance** knob to select **Monitor Downmix** source. See [Figure 3-5](#) on page 40 for the display.

Figure 3-5 Select Monitor Mix for the Input

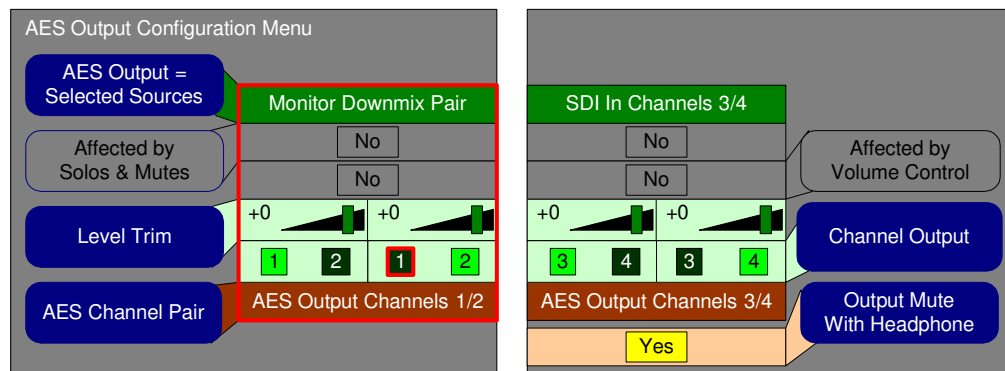

- You can repeat this procedure on other AES or analog outputs if you need additional duplicate monitor mix outputs. Press the **✓** button twice to return to the **Main Screen**.

AES and Analog Outputs

Any monitored input can be routed to any AES or analog output pair. This powerful feature will allow de-embedded, Dolby decoded, or other digital or analog audio to be used by other products. The audio that is output doesn't necessarily need to be monitored by the meters or speakers. You can easily configure this in the **AES Output Menu** and the **Analog Output Menu**.

The AMP1-16 Series monitors contain both AES and analog outputs. The sources of these outputs are set using the **AES Output Configuration Menu** and **Analog Output Configuration Menu**. The parameters that these menus adjust are as follows:

1. You can map either or both of these output ports pair-wise either to the channel pairs that are metered and audibly monitored, or to a selection of the SDI and AES inputs.
2. If you map the output ports to the metered (and audibly monitored) channel pairs, then you can also specify whether the outputs should be affected by the:
 - A. **Solo** and **Mute** hot keys,
 - B. Front panel **Volume** control and **Balance** knobs, and/or
 - C. Insertion of a headphone in the front panel jack.

These settings are for typical use with an external surround sound system.

3. If you map the output ports to selected sources, then you can use them in a variety of useful roles, independent of monitoring and metering. For example:
 - A. The SDI input pairs can be de-embedded into AES streams or into analog audio.
 - B. The AES input pairs can be swapped pair-wise under control of the AMP1-16 Series monitor to the AES outputs.

Chapter 3 Audio and Metering
Configuring the Audio Outputs

- C. The AES input pairs can be converted into analog audio.

Table 3-1 Available Signal Types/Channels

Signal Sources	Available Channel Pairs
SDI	1 through 8
AES	1 through 8
Dolby	1 through 5
Monitor Mix	1 through 8
Off	

- 4. Each AES or analog output channel has its own individual volume trim control with a range from -60 to +12 dB in 1 dB steps.
- 5. You can turn each channel on or off independently.

The pin-out of the unbalanced AES output connectors is listed in [Table 3-2](#) below.

Table 3-2 Unbalanced AES Output Connector Pin Out

Pin	AES Out 1-4 Function	AES Out 5-8 Function	Use
1.	AES Pair 1	AES Pair 5	Unbalanced AES Outputs
2.	AES Pair 2	AES Pair 6	
3.	AES Pair 3	AES Pair 7	
4.	Ground	Ground	Chassis Ground Return
5.	Ground	Ground	
6.	Ground	Ground	
7.	Ground	Ground	
8.	Ground	Ground	
9.	Ground	Ground	
10.	Ground	Ground	
11.	Ground	Ground	
12.	Ground	Ground	Unbalanced AES Outputs
13.	AES Pair 4	AES Pair 8	
14.	Ground	Ground	
15.	Ground	Ground	

The pin-out of the balanced analog output connector is listed in [Table 3-3](#) below.

Table 3-3 Balanced Analog Output Connector Pin Out

Pin	Function	Use
1.	Channel 8 (+)	Non-inverted Balanced Analog Output
2.	Ground	Channel 8 Shield
3.	Channel 7 (-)	Inverted Balanced Analog Output
4.	Channel 6 (+)	Non-inverted Balanced Analog Output
5.	Ground	Channel 6 Shield
6.	Channel 5 (-)	Inverted Balanced Analog Output
7.	Channel 4 (+)	Non-inverted Balanced Analog Output
8.	Ground	Channel 4 Shield
9.	Channel 3 (-)	Inverted Balanced Analog Output
10.	Channel 2 (+)	Non-inverted Balanced Analog Output
11.	Ground	Channel 2 Shield
12.	Channel 1 (-)	Inverted Balanced Analog Output
13.	(NC)	Not Used
14.	Channel 8 (-)	Inverted Balanced Analog Output
15.	Channel 7 (+)	Non-inverted Balanced Analog Output
16.	Ground	Channel 7 Shield
17.	Channel 6 (-)	Inverted Balanced Analog Output
18.	Channel 5 (+)	Non-inverted Balanced Analog Output
19.	Ground	Channel 5 Shield
20.	Channel 4 (-)	Inverted Balanced Analog Output
21.	Channel 3 (+)	Non-inverted Balanced Analog Output
22.	Ground	Channel 3 Shield
23.	Channel 2 (-)	Inverted Balanced Analog Output
24.	Channel 1 (+)	Non-inverted Balanced Analog Output
25.	Ground	Channel 1 Shield

Level Metering

Overview

The AMP1-16 Series monitors are capable of showing 16 level meters simultaneously along with a loudness indication. The signals for the level metering are always the same ones that are monitored through the **Monitor Mixer Menu**, which also controls the internal speakers. These signals may be de-embedded SDI audio, AES audio, decoded Dolby, or a combination of input types.

Figure 3-6 illustrates the menus used to modify the audio meters: the various signal inputs, the menus used to configure them, and their outputs.

Figure 3-6 Meter Routing Diagram

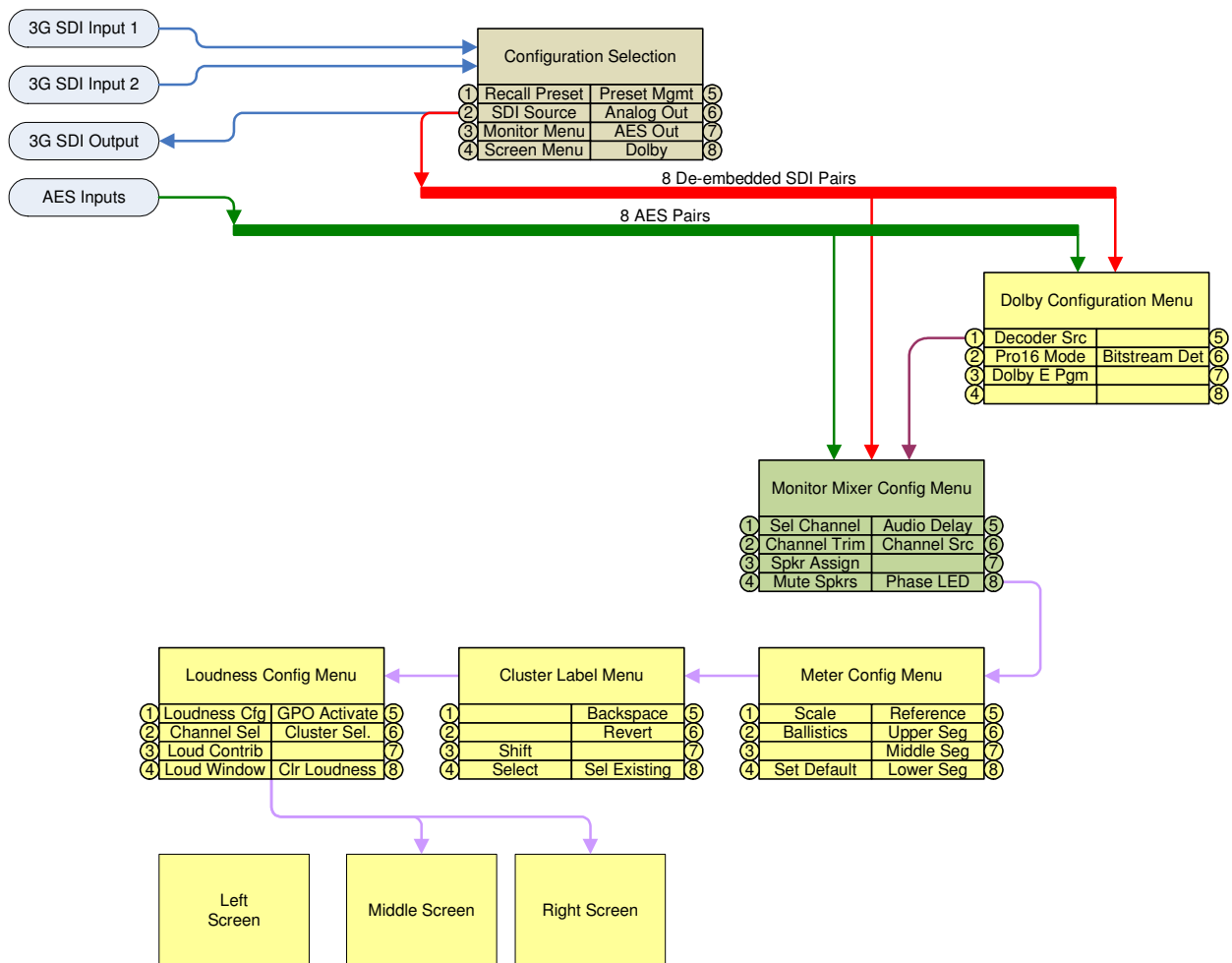

Metering Menus

The display of the level meters and related visual indications is determined as follows:

1. The source for each of the 16 level meters is set in the **Monitor Mixer Configuration Menu**. The phase indicators are also enabled or disabled in this menu.
2. The meter scale, ballistics, limits, reference level, as well as segment colors and transition points are set in the **Meter Configuration Menu**.
3. The clustering of the meters into logical arrangements is set in the **Cluster Configuration Menu**.
4. The loudness indication is set up in the **Loudness Configuration Menu**.

Note: The **Volume** and **Balance** levels also display graphically at the top of the **Main Screen** while you are adjusting them.

CHAPTER 4

Video and Data

Introduction

Overview

This chapter describes how to configure the AMP1-16V-MD and AMP1-E16V-MD to display both video and data.

Topics

Topics	Page
Introduction	47
Configuration Options	48

Configuration Options

Overview

The AMP1-16V-MD will display a variety of 3G, HD, and SD video formats. It supports two 3G SDI inputs that can be alternately selected. The selected SDI input is reclocked and output.

The video signal paths within the AMP1-16V-MD are set up using the menu screens.

Figure 4-1 illustrates the menus used to modify the video signals, the various signal inputs, the menus used to configure them, and their outputs.

Figure 4-1 Video Routing Diagram

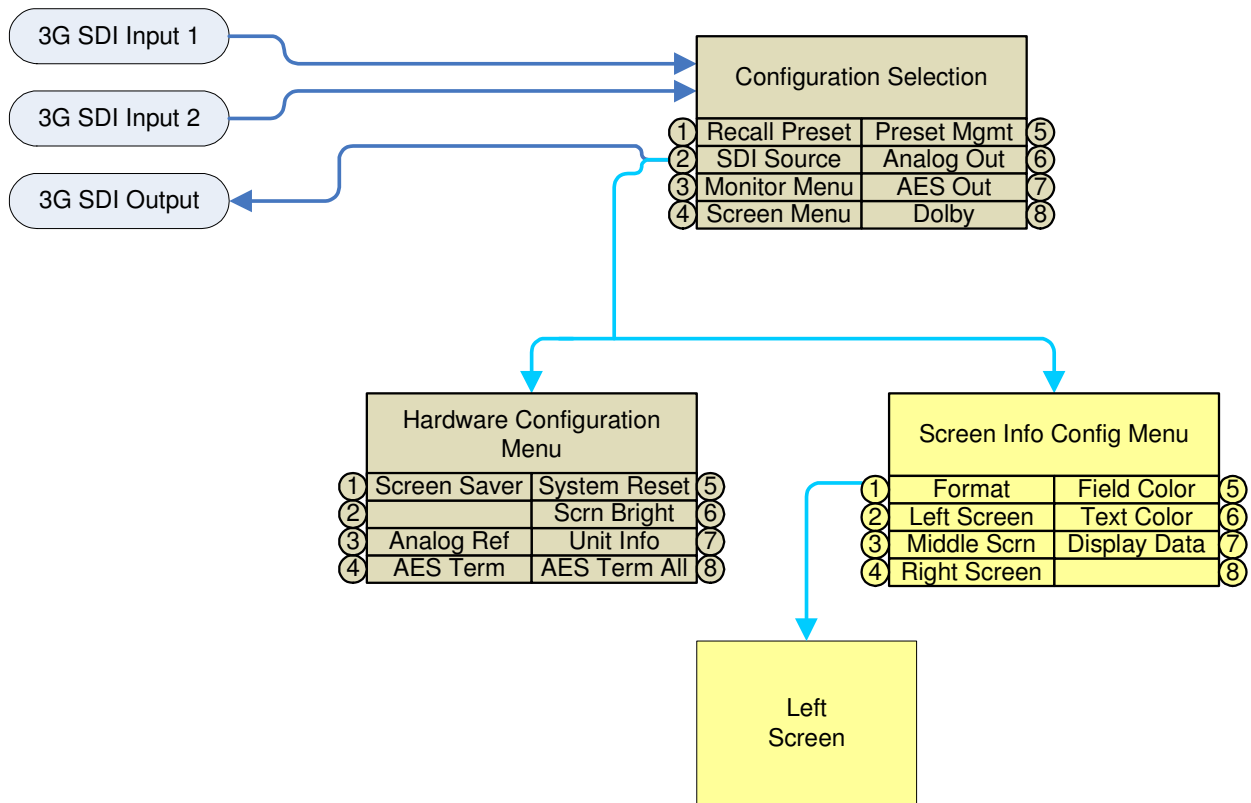

Video Menu

The display of the level meters and related visual indicators is determined as follows:

1. Select the SDI source for video from the **Configuration Selection Menu**.
2. Select the format setting in the **Screen Information Configuration Menu** to direct either video or data to the left-hand screen.

CHAPTER 5

Efficiency Enhancements

Introduction

Overview

This chapter describes the processes of creating presets and hot keys. These features allow you to configure the AMP1-16V-MD and AMP1-E16V-MD and then save those settings for immediate recall.

Topics

Topics	Page
Introduction	51
Presets	52
Hot Keys	55
General Purpose Inputs and Outputs (GPI/Os)	62
Turning Active Help On or Off	63

Presets

Overview

Modifying the menu settings allows you to configure the entire AMP1-16 Series monitor to function exactly the way you want it to for your specific application. This complete system configuration is called a *preset*. After saving the preset, you can then quickly recall it by pressing a single button. Presets are often used to quickly select different combinations of inputs to monitor. Moreover, the monitor has the capacity to hold eight presets; that is, eight complete system configurations.

Saving Presets

You can save new configuration changes to the same preset or to a different one. If you would like to have two presets that are largely the same except for certain settings, set up one of them first and save it to the first preset. Then make the changes that differentiate the two presets and save this to a second preset. You can then recall either preset as you need it.

1. Once you have the monitor configured the way you want it, press the **Manage Presets** button (from the **Configuration Selection Menu**) to display the **Preset Management Menu**.
2. Press the **Save Current** button and then rotate the **Balance** knob to display the preset number you want to save the configuration to.
3. Press the **Balance** knob to save the preset. This will take you to the **Label Menu** where you can rename the preset.
4. Once you have labeled the preset, press **Save** until you get back to the **Main Screen**.
5. To return to the **Main Screen**, press the **Save/Exit** button twice.

Recalling Presets

You can recall the preset of your choice at any time in several different ways:

1. From the **Configuration Selection Menu**, press the **Recall Preset** button to recall a preset. Rotate the **Balance** knob to select the desired preset, and then *press* the **Balance** knob. Now the complete system configuration saved in that preset becomes the current configuration of the AMP1-16 Series monitor.
2. Using the **Hot Key Configuration Menu**, you can assign any of the eight hot keys surrounding the **Main screen** to function as a preset changer. This is the quickest way to change the presets because it only involves pressing a single hot key.
3. Again, using the **Hot Key Configuration Menu**, you can assign one of the eight hot keys surrounding the **Main screen** to become a selectable preset. To use this hot key, press it, rotate the **Balance** knob to select the desired preset, then press the **Balance** knob. This selected preset will then take effect.

Naming or Renaming

This section describes how to name or rename a preset, hot key, or cluster.

1. From the **Configuration Selection Menu**, press the **Preset Management** button to display the **Preset Configuration Menu**.
2. In the **Preset Configuration Menu**, press the **Rename Preset** key.
3. Rotate the **Balance** knob to select the preset you want to rename, and press the **Balance** knob to display the **Label Menu**.
4. If needed, press the **Backspace** button until the unwanted text disappears.
5. Use the **Shift** button to toggle between upper and lower case letters. Note that the symbols (on the bottom row) remain constant.

Label Example

In this example, we will create a label: *My Config*.

1. Press the **Shift** button to display the upper case character set.
-

2. Press the **Select** button to initiate the **Balance** knob for character selection.
3. *Rotate* the **Balance** knob until the *M* is highlighted.
4. *Press* the **Balance** knob to select the character.
5. Press the **Shift** button to display the lower case character set.
6. Note that you do *not* need to press the **Select** button a second time; simply rotate the **Balance** knob until the *y* is highlighted.
7. Press the **Balance** button to select it.

Repeat this process for each character of the label. Note that the space bar character is immediately to the right of the 9. To correct mistakes, press the **Backspace** button.

8. To save the new label and return to the **Preset Configuration Menu**, press the ✓ button.
9. To verify your changes, look at the text to the right of the **Rename Preset** button. Your preset should still be in the display area with its new name.

Clearing a Preset

1. From the **Configuration Selection Menu**, press the **Preset Management** key to display the **Preset Configuration Menu**.
2. Press the **Clear Preset** button.
3. Rotate the **Balance** knob to highlight the preset you want to clear.
4. Press the **Balance** knob to select the preset.

Important: The monitor will display a warning message to let you know that you are about to clear the preset. You must respond by pressing the **Clear Preset** button again before the warning disappears (approximately five seconds) or you must start over by pressing the **Clear Preset** button again.

Recalling a Preset On Power Up

After a power fail or deliberate power shutdown, you can define how the AMP1-16V-MD configures itself when power is restored.

1. From the **Configuration Selection Menu**, press the **Preset Management** key to display the **Preset Configuration Menu**.
2. Press the **Recall on Power Up** key.
3. Rotate the **Balance** knob to select the preset to be recalled at power up, and press the **Balance** knob.

Hot Keys

Overview

Hot keys allow you to make immediate configuration changes “at the touch of a button” without using the menu system. Hot keys can be:

- Solos,
- Mutes,
- Preset changers, or
- Off.

For more information on creating a preset, refer to [Presets on page 52](#).

Mutes and Solos

A **muted** hot key identifies the channels that are silenced when the knob is pressed and leaves all other channels audible. A **solo** hot key identifies the channels that are audible while all other channels are silenced. As you can see, these two functions are inverses of each other. Using hot keys to solo and/or mute becomes extremely useful when trying to identify specific sounds that may exist in one channel but not

in another. Note that both the mute and the solo functions allow you to select more than one channel.

Defining/Modifying a Hot Key

1. From the **Configuration Selection Menu**, press the **Screen Display Menu** button to display the **Screen Display Menu**.
2. Press the **Hot Key Menu** button to display the **Main Screen Hot Key Button Configuration Menu**.
3. To select a button to define, press that button to highlight its name.
4. Rotate the **Balance** button to move the highlight to the function field, which will read either **solo**, **mute**, **pre** (short for preset), or **off**.
5. Pressing the **Balance** knob selects the function displayed: **off**, **mute**, **solo**, or **pre**.
6. Once the function you want is highlighted, rotate the **Balance** knob again to sequence the highlight through each of the channel numbers (or preset numbers).
7. To select a channel for this function, press the **Balance** knob when the channel you want is highlighted. Unselecting a channel works the same way.
8. Selecting a preset works similarly, except that only one preset may be selected for each hot key.

Hot Key Example

In this example we will modify Button 8 to mute Channels 4 and 8.

1. On the **Main Screen Hot Key Button Configuration Menu**, press the bottom, right-hand button.
 2. Rotate the **Balance** knob to highlight the function field.
 3. Press the **Balance** knob repeatedly until the function field displays **Mute**.
 4. Now rotate the **Balance** knob again until you highlight Channel 4.
-

-
5. When Channel 4 is highlighted, press the **Balance** knob to select it.
 6. Now rotate the **Balance** knob again until you highlight Channel 8.
 7. When Channel 8 is highlighted, press the **Balance** knob to select it.
 8. Use this same procedure to unselect any channels that are selected that you do not want to mute.
 9. Continue on to the [Hot Key Naming Example on page 58](#).
-

Creating a Preset Hot Key

Presets can be either defined or selectable. For more information on creating a preset, refer to [Presets on page 52](#).

Selectable Preset Hot Key Example

In this example we will modify the bottom, left-hand knob so that it becomes a preset hot key.

1. On the **Main Screen Hot Key Configuration Menu**, press the bottom, left-hand button to highlight the button's label.
 2. Rotate the **Balance** knob until the function field (displaying **Off**, **Solo**, **Mute**, or **Pre**) is highlighted.
 3. Press the knob repeatedly until **Preset to Recall** displays.
 4. Now, rotate the **Balance** knob again to highlight the desired preset to recall or **Selectable**.
 5. Press the knob to select the desired preset to recall or **Selectable**.
-

Naming/Renaming a Hot Key

Once you have successfully defined a hot key's functionality, you can rename the label that displays on the **Main Screen**.

1. From the **Configuration Selection Menu**, press the **Screen Display Menu** button to display the **Screen Display Menu**.

Chapter 5 Efficiency Enhancements

Copying Presets to Another Monitor

2. Press the **Hot Key Menu** button to display the **Main Screen Hot Key Button Configuration Menu**.
3. To select a button to define, press that button to highlight its name.
4. Press the **Balance** knob to display the **Label Menu**.

Hot Key Naming Example

In this example we will rename **Button 8** to match the functionality we just defined in the previous example.

1. On the **Main Screen Hot Key Button Configuration Menu**, press Button 8 (bottom, right-hand side). The name field should be highlighted.
 2. Press the **Balance** knob to display the **Label Menu**.
 3. From here, continue on with the instructions in the [Label Example on page 53](#) since the instructions for using the **Label Menu** are identical.
-

Copying Presets to Another Monitor

If you have purchased more than one AMP1-16 Series monitor, you may want to copy your presets from one monitor to another one. If so, follow the instructions below.

Important: Verify that you have, in fact, saved your configurations to presets. See [Saving Presets on page 52](#) for details.

Preset Files

A *preset file* contains all eight presets, and all other saved settings of the current system configuration (whether saved as a preset or not) of an AMP1-16 Series monitor.

Verifying Compatibility

Important: If the two AMP1-16 Series monitors are not compatible, you should not attempt to copy the preset file. Doing so will reset the duplicated monitor to the factory defaults.

You can determine whether two AMP1-16 Series monitors are compatible based on two characteristics:

- The presence/absence of a Dolby Card
- The **NvRam Table Version**

To verify that the two AMP1-16 Series monitors are compatible, follow the steps below.

1. Power up the first AMP1-16 Series monitor and navigate to the **Unit Information Menu**.
 - A. When the **Main Screen** appears, press either the ✓ button or the ✕ button to display the **Configuration Selection Menu**.
 - B. When the **Configuration Selection Menu** appears, press the **Screen Display Menu** button to display the **Screen Display Menu**.
 - C. When the **Screen Display Menu** appears, press the **Option Menu** button to display the **Options Configuration Menu**.
 - D. When the **Options Configuration Menu** appears, press the **Hardware Config** button to display the **Hardware Configuration Menu**.
 - E. When the **Hardware Configuration Menu** appears, press the **Unit Info SW** button to display the **Unit Information Menu** as shown in [Figure 5-1](#) below.

Figure 5-1 Unit Information Menu

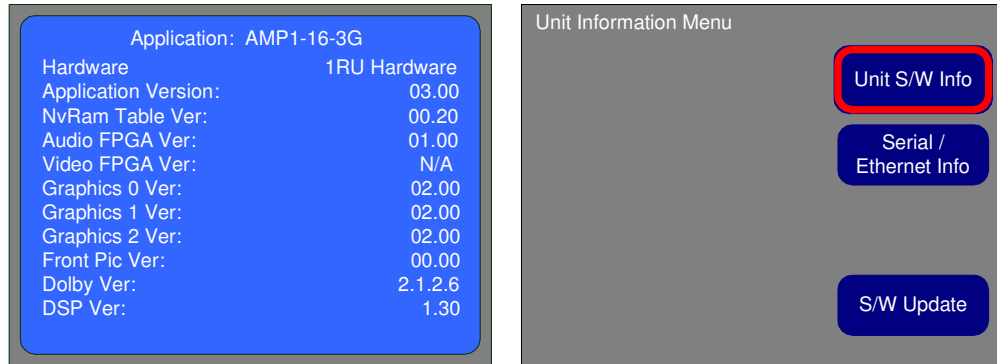

- When the **Unit Information Menu** appears, make a note of the following:

NvRam Table Version: _____

Dolby Version: _____

- Power up the second AMP1-16 Series monitor and repeat the previous Steps (1 through 2) above.

Decision Point:

If the NvRAM versions are the same for both units, then they are compatible. (It is also acceptable for the source unit to display “N/A” and the target unit to have a version number.) Continue on to [Backing Up the Saved Presets](#) immediately below.

Otherwise, if one or more of the lines in Step 2 is not the same, then this procedure will not work. You can do one of two things:

- Manually configure the second AMP1-16 Series monitor, or
- If the units have the same hardware and software versions, then you can upgrade the software on one, or both units so that the **NvRam Table Versions** match. Then after reconfiguring the first one manually, you can use this procedure to copy its preset file to the second one.

Backing Up the Saved Presets

Note: These instructions assume that neither of the AMP1-16 Series monitors have been configured to connect to your PC. If they have already been configured, skip only Step 2.

1. Create a folder on your PC's desktop called **Presets**.
2. Follow the instructions in [Appendix 9 on page 113](#) to establish connectivity to the AMP1-16 Series monitor.
3. Follow the instructions in [Appendix 10 on page 131](#) to set up the AMP1-16 Series monitor for an FTP file transfer.
4. Press the F5 key to refresh the window.
5. Drag and drop the **Presets.S19** file from the AMP1-16 Series monitor to the **Presets** folder on the desktop.
6. We recommend that you rename the file so you can distinguish multiple presets files. You must, however, maintain two parts of the filename (both of which are case-sensitive):
 - The word **Presets** (plural) must appear in the filename.
 - The file's extension must be **.S19**.

Important: If the new filename does not meet the requirements listed in Step 6 above, the AMP1-16V-MD Series monitor will not accept the file.

Examples:	Acceptable filenames:	Unacceptable filenames:
	<ul style="list-style-type: none">• My Presets.S19• 090909 Presets.S19	<ul style="list-style-type: none">• My Preset Set.S19• My presets.s19

7. Once the file is copied, disconnect the AMP1-16 Series monitor from the PC.

Important: This concludes this half of the preset copying procedure. Continue on to [Copying the Presets to Another Monitor](#) immediately below.

Copying the Presets to Another Monitor

1. Connect the destination AMP1-16 Series monitor to your PC.

Chapter 5 Efficiency Enhancements

General Purpose Inputs and Outputs (GPI/Os)

2. Follow the instructions in [Appendix 9 on page 113](#) to establish connectivity to the AMP1-16 Series monitor.
3. Follow the instructions in [Appendix 10 on page 131](#) to set up the AMP1-16 Series monitor for an FTP file transfer.
4. Drag and drop the **Presets.S19** file (or the file you renamed in Step 6 at the top of this page) from your **Presets** folder to the AMP1-16 Series monitor.

Note: Transferring the preset file to the AMP1-16 Series monitor will reset it and then it will return to the ftp-enabled state.

5. Press the **Help** (left) navigation button on the AMP1-16 Series monitor to restart it and load the new presets into memory.

Important: This concludes the entire preset copying procedure.

General Purpose Inputs and Outputs (GPI/Os)

The AMP1-16V-MD contains eight General Purpose Inputs (GPIs) and two General Purpose Outputs (GPOs). The inputs (GPIs) are detected as DC voltages between 12 and 24 VDC. Their action replicates the action of the hot keys on the front panel. Since you can assign the action of the hot keys to a variety of functions using the **Main Screen Hot Key Button Configuration Menu**, the GPIs can therefore change presets, mute sets of channels, or solo sets of channels.

The first General Purpose Output (GPO) is activated when the loudness is equal to or greater than a level set using the GPO activate function in the **Loudness Configuration Menu**. The second GPO is not used,

but it is reserved for future functionality. The pin out of the GPI/O (inputs and/or outputs) connector is listed in [Table 5-1](#) below.

Table 5-1 GPI/O Connector Pin Out

Pin	Function	Use
1.	GPO 1 (N.O.)	Normally Open and Normally Closed GPO Contacts
2.	GPO 1 (N.C.)	
3.	GPO 2 (N.O.)	
4.	GPO 2 (N.C.)	
5.	GPI 1	Positive or negative 12-24 VDC General Purpose Inputs
6.	GPI 2	
7.	GPI 3	
8.	GPI 4	
9.	GPI 5	
10.	GPI 6	
11.	GPI 7	
12.	GPI 8	
13.	GPI Common	Return for 12-24 VDC GPI Signals
14.	GPO 1 (Com)	Armature Contact for GPO 1
15.	(NC)	Not Used
16.	GPO 2 (Com)	Armature Contact for GPO 2
17.	(NC)	Not Used
18.	(NC)	
19.	(NC)	
20.	(NC)	
21.	(NC)	
22.	(NC)	
23.	(NC)	
24.	(NC)	
25.	(NC)	

Turning Active Help On or Off

1. From the **Configuration Selection Menu**, press the **Screen Display** button to display the **Screen Display Menu**.
2. Press the **Options Menu** button to display the **Options Configuration Menu**.

Chapter 5 Efficiency Enhancements

Turning Active Help On or Off

3. Press the **Active Help** button to toggle the help display on the video monitor on or off.

CHAPTER 6

Menu List

Introduction

Overview

This chapter provides an in-depth description of all the features, specifications, and menus and all their respective options and functions. Note that the menus are listed alphabetically for easy reference.

Topics

Topics	Page
Menu Navigation Overview	66
AES Output Configuration Menu	68
Analog Output Configuration Menu	70
Configuration Selection Menu	72
Cluster Configuration Menu	73
Dolby Setup Menu	74
Hardware Configuration Menu	75
Label Menu Screen	77
Loudness Configuration Menu Screen	78
Main Screen	79
Main Screen Hot Key Button Configuration Menu	81
Meter Configuration Menu	82
Monitor Mixer Configuration Menu	84
Option Configuration Menu	86

Topics (Continued)	Page
Preset Management Menu	87
Screen Display Menu	88
Screen Information Setup Menu	89
Unit Information Menu	91

Menu Navigation Overview

You can launch the menu system by pressing either of the small buttons directly below the **Balance** control. These same buttons also either the ✓ (**Save and Exit**) or the X (**Cancel and Exit**). Context-sensitive, active help appears automatically on the left hand screen for any function.

The configuration menus (shown in [Figure 6-1 on page 67](#)) appear on the AMP1-16V-MD and AMP1-E16V-MD to display information and to allow you to configure the operation of the monitor.

Figure 6-1 Menu Tree

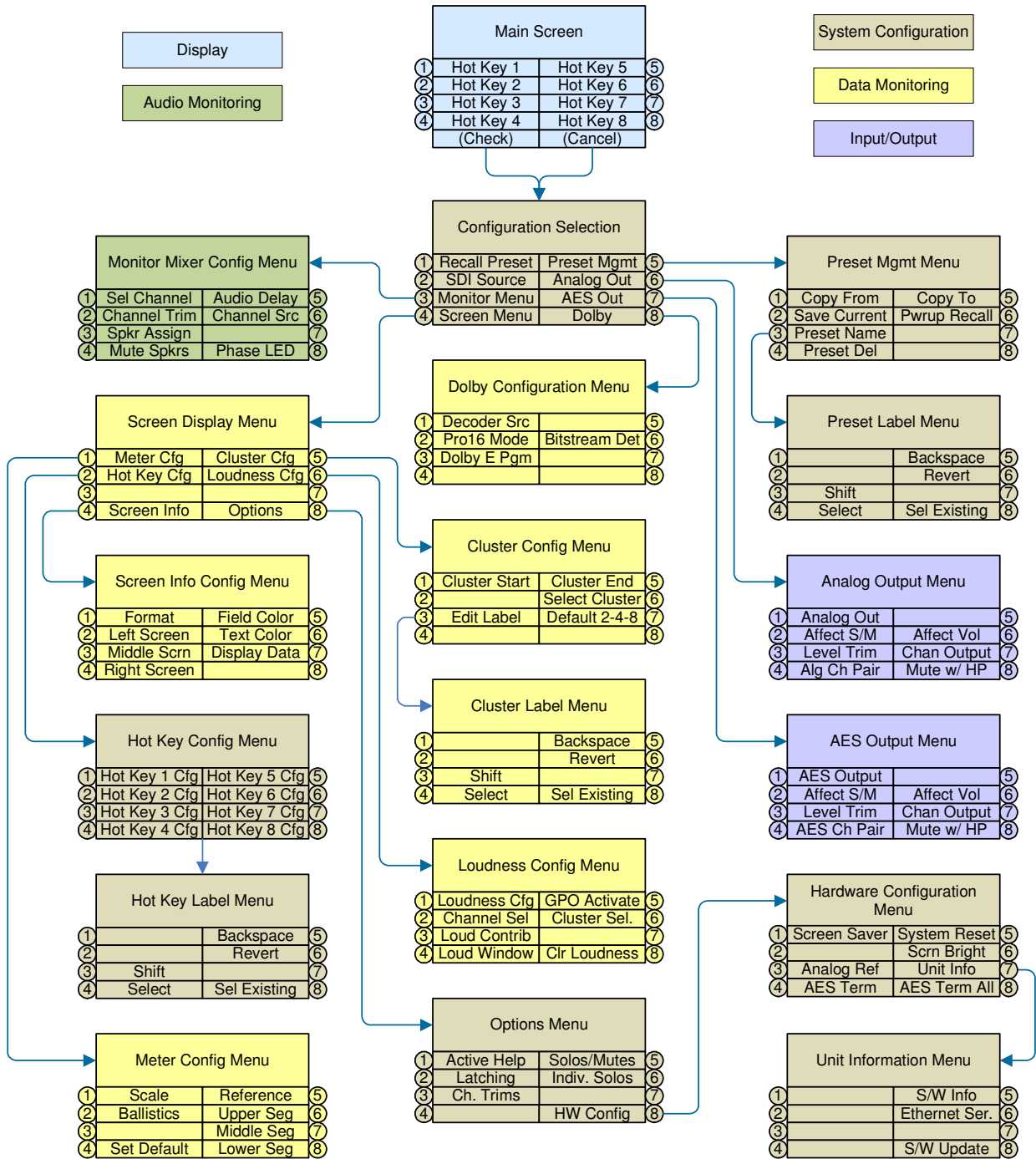

AES Output Configuration Menu

Figure 6–2 AES Output Configuration Menu (Selected Sources)

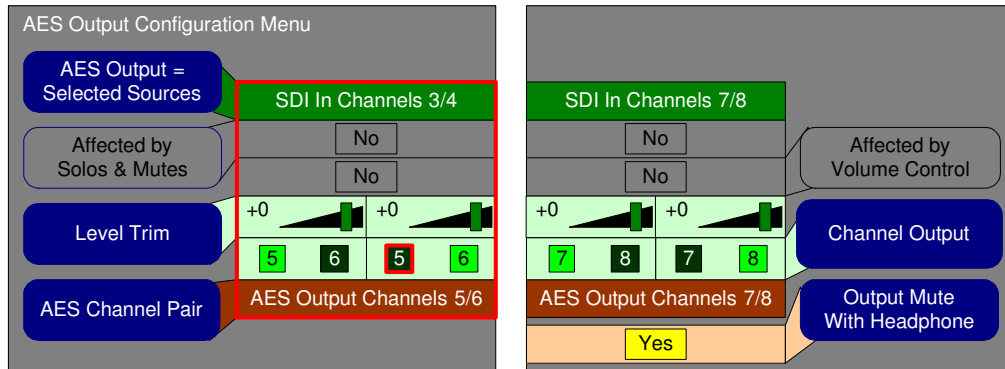
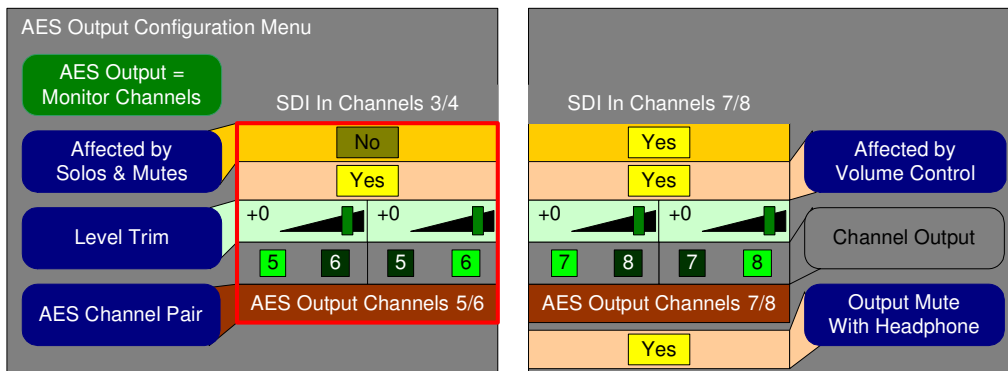

Figure 6–3 AES Output Configuration Menu (Monitor Channels)



- **AES Output:** This button will either be labeled **AES Output = Selected Sources** or **AES Output = Monitor Channels** as shown in the two figures above. Pressing this button highlights it. Subsequent presses toggle between its two choices. If the **AES Output = Selected Sources** is chosen, the **Balance** knob can then be rotated to select no source (**None**) or the SDI or AES pair is assigned as a source. In a unit with Dolby enabled, the five decoded output pairs are added.
- **Affected by Solos & Mutes:** This option is only available when the AES output is set to monitor channels. When it is not available, it is disabled and the options are set to **No**. When it is available, it determines whether the **Main Screen** solo and mute buttons will

affect each channel pair. Pressing this button highlights it. Subsequent presses toggle between **Yes** and **No** for the selected channel pair.

- **Level Trim:** Pressing this control selects the left, the right, or both level trim controls in the selected pair. Selection is indicated by the “handle” blinking light green and dark green. Rotating the **Balance** knob changes the gain. The change is indicated both graphically and numerically.

Pressing the **Balance** control knob returns the trim(s) to unity gain. This control has a range of -60 dB to +12 dB (inclusive) in 1 dB steps.

The channel can be muted by turning this control counterclockwise beyond -60 dB.

- **AES Channel Pair:** Pressing this button and then rotating the **Balance** control knob takes you through each of the eight channel pairs of the AES output port. The other controls on this menu affect the selected pair.
- **Affected by Volume Control:** This option is only available when the AES output is set to **Monitor Channels**. When it is not available, it is disabled and the options are set to **No**. When it is available, it determines whether the main Volume control will affect each channel pair. Pressing this button highlights it. Subsequent presses toggle between **Yes** and **No** for the selected channel pair.
- **Channel Output:** This adjustment is only available when the AES output is not set to **Monitor Channels**. This is because when **Monitor Channels** is selected, the AES outputs will follow the channels selected in the **Monitor Menu**.

Pressing this button highlights the first channel select indicator. Subsequent presses toggle between the two indicators. Rotating the **Balance** knob moves the highlight through the four indicators in the selected channel pair. Pressing the **Balance** knob toggles the selected indicator **On** or **Off** (bright green or dark green). Doing this will assign each channel to either, both, or neither of the AES channel outputs.

- **Output Mute with Headphone:** Pressing this button highlights it. Subsequent presses toggle between **Yes** and **No** for the AES output.

Analog Output Configuration Menu

Figure 6-4 Analog Output Configuration Menu (Selected Sources)

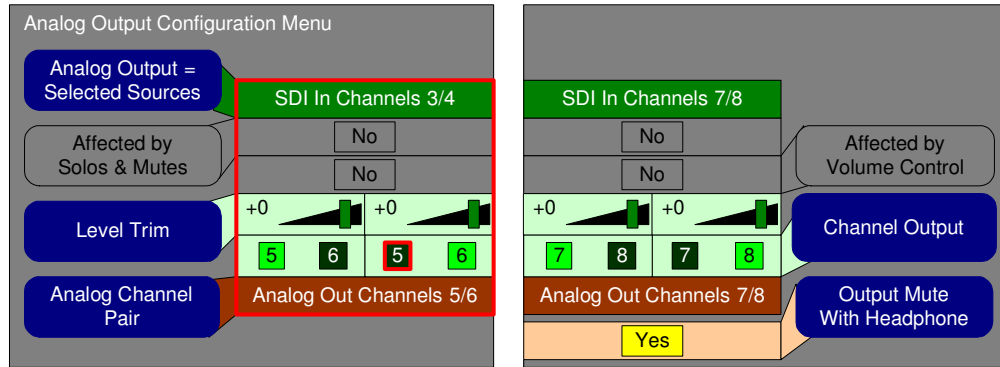
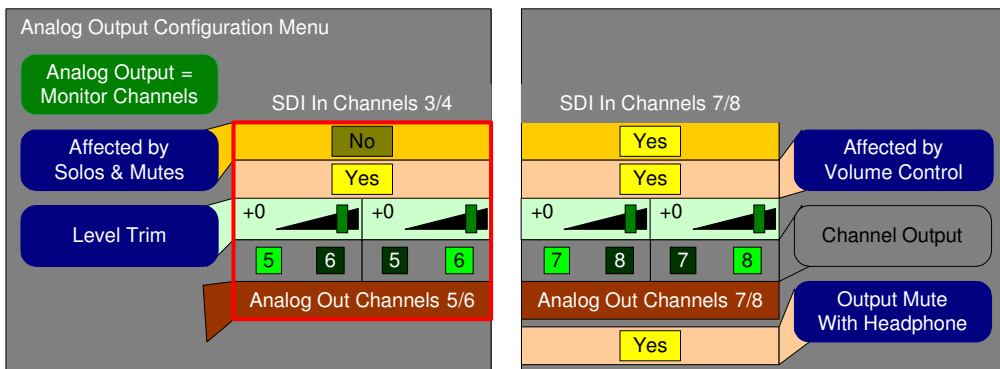

Figure 6-5 Analog Output Configuration Menu (Monitor Channels)



- **Analog Output:** This button will either be labeled **Analog Output = Selected Sources** or **Analog Output = Monitor Channels** as shown in the two figures above. Pressing this button highlights it. Subsequent presses toggle between its two choices. If the **Analog Output = Selected Sources** is chosen, the **Balance** knob can then be rotated to select no source (**None**) or the SDI or AES pair assigned as a source. In a unit with Dolby enabled, the five decoded output pairs are added.
- **Affected by Solos & Mutes:** This option is only available when the analog output is set to monitor channels. When it is not available, it is disabled and the options are set to **No**. When it is available, it determines whether the **Main Screen Solo** and **Mute** buttons will

affect each channel pair. Pressing this button highlights it. Subsequent presses toggle between **Yes** and **No** for the selected channel pair. The factory default is **No**.

- **Level Trim:** Pressing this control selects the left, the right, or both level trim controls in the selected pair. Selection is indicated by the “handle” blinking light green and dark green. Rotating the **Balance** knob changes the gain. The change is indicated both graphically and numerically.

Pressing the **Balance** control knob returns the trim(s) to unity gain. This control has a range of -60 dB to +12 dB (inclusive) in 1 dB steps.

The channel can be muted by turning this control counterclockwise beyond -60 dB.

- **Analog Channel Pair:** Pressing this button and then rotating the **Balance** control knob takes you through each of the four channel pairs of the analog output port. The other controls on this menu affect the selected pair.
- **Affected by Volume Control:** This option is only available when the analog output is set to monitor channels. When it is not available, it is disabled and the options are set to **No**. When it is available, it determines whether the **Volume** control will affect each channel pair. Pressing this button highlights it. Subsequent presses toggle between **Yes** and **No** for the selected channel pair.
- **Channel Output:** This adjustment is only available when the analog output is not set to monitor channels since the AES outputs will follow the channels selected in the **Monitor Menu**.

Pressing this button highlights the first channel select indicator. Subsequent presses toggle between the two indicators. Rotating the **Balance** knob moves the highlight through the four indicators in the selected channel pair. Pressing the **Balance** knob toggles the selected indicator on or off (bright green or dark green). Doing this will assign each channel to either, both, or neither of the analog channel outputs.

- **Output Mute with Headphone:** Pressing this button highlights it. Subsequent presses toggle between **Yes** and **No** for the analog output.

Configuration Selection Menu

Figure 6–6 Configuration Selection Menu

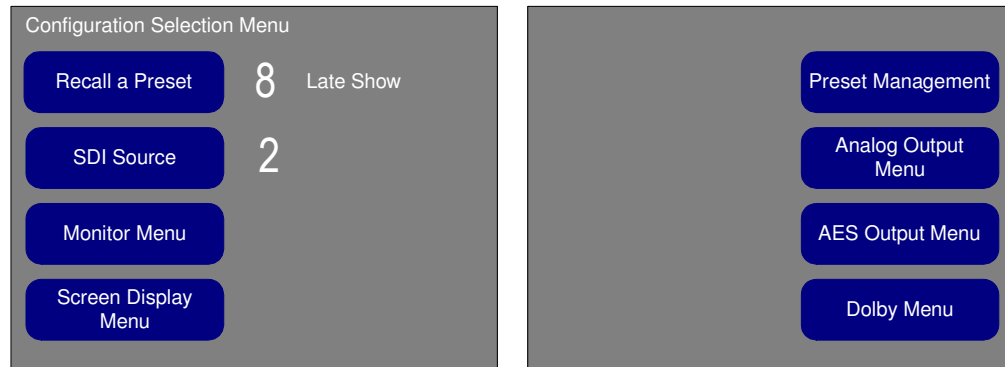

- **Recall a Preset:** To recall a preset, press the button, rotate the **Balance** knob until the desired preset is shown, and then press the **Balance** knob.
- **SDI Source:** Press the button to toggle between the two sources.
- **Monitor Menu:** Pressing this button calls up the **Monitor Mixer Configuration** screen, which allows you to define the mix of input pairs you hear in the speakers and other outputs.
- **Screen Display Menu:** Progresses to another menu screen which contains access to other menus to configure what is displayed on the **Main Screen**.
- **Preset Configuration Menu:** Progresses to a menu to save, name, and manage presets.
- **Analog Output Menu:** Displays the **Analog Output Menu** where you can set up and adjust the four analog output pairs.
- **AES Output Menu:** Displays the **AES Output Menu** where you can set up and adjust the eight AES output pairs.
- **Dolby Setup:** Displays the **Dolby Configuration Menu** where you can set up the Dolby decoder parameters. This button only appears on the AMP1-E16V-MD.

Cluster Configuration Menu

Figure 6–7 Cluster Configuration Menu

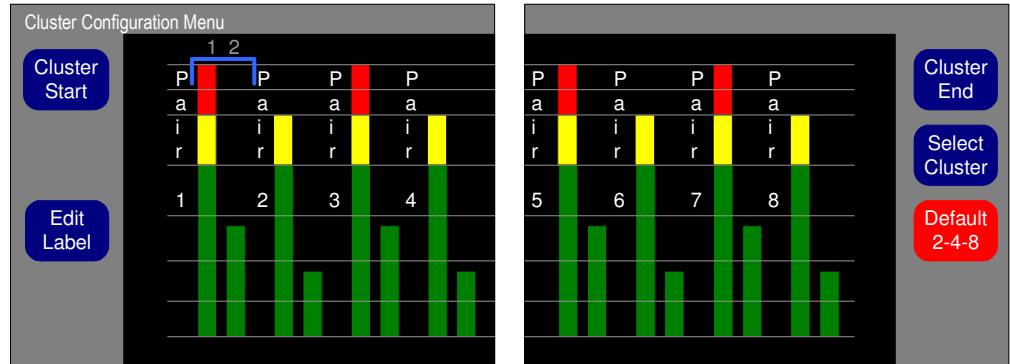

This menu allows you to configure the clustering of the channels on the **Main Screen**. Cluster labels can also be changed from this menu.

With the combination of the controls in the **Monitor Mixer Configuration Menu**, and the channel clustering in this menu, you have a very powerful, intuitive tool to arrange the metering and monitoring options on the **Main Screen** so you can tell at a glance what is happening with the monitored sources.

- **Cluster Start:** Pressing this button and then rotating the **Balance** knob moves the left side of the blue bracket to select the starting channel of a cluster. Pressing the **Balance** knob sets the new cluster.
- **Edit Cluster Label:** Pressing this control proceeds to the **Label Menu** to allow you to enter or change the cluster label, shown in the [Figure 6-7](#) as “Pair 1.”
- **Cluster End:** Pressing this button and then rotating the **Balance** knob moves the right side of the blue bracket to select the ending channel of a cluster. Pressing the **Balance** knob sets the new cluster. Channels from other existing clusters are automatically removed and added to the one being set.
- **Select Cluster:** Pressing this button and then rotating the **Balance** knob moves the blue selection bracket from cluster to cluster to allow adjustment of each one.

Chapter 6 Menu List

Dolby Setup Menu

- **Default 2-4-8:** Pressing this button and then rotating the **Balance** knob selects two, four, or eight. Pressing the **Balance** knob reformats the screen to form:
 - Two clusters of eight channels each,
 - Four clusters of four channels each, or
 - Eight clusters of two channels each.

The factory default is eight clusters of two channels each.

Dolby Setup Menu

Figure 6–8 **Dolby Setup Menu**

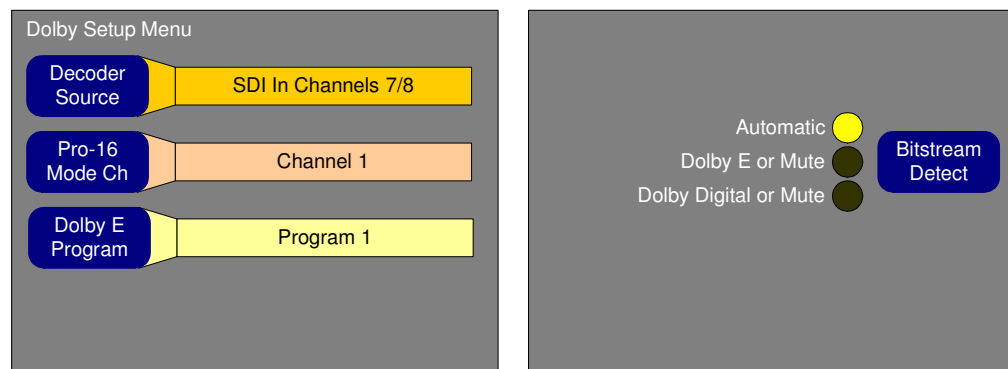

- **Decoder Source:** Pressing this control and then rotating the **Balance** knob selects the source of the Dolby CAT 552 card. The source choices include all AES input pairs and all SDI de-embedded pairs.
- **Pro-16 Mode Channel:** Pressing this control and then rotating the **Balance** knob selects the Pro-16 Mode channel.
- **Dolby E Program:** Pressing this control and then rotating the **Balance** knob selects the Dolby E program.
- **Bitstream Detect:** This field allows you to identify how you want the monitor to respond in the absence of the Dolby bitstream. Press this button and rotate the balance control to cycle through the three available options: **Automatic**, **Dolby E or Mute**, and **Dolby Digital or Mute**.

- **Automatic:** When this option is selected, the Dolby Decoder will automatically detect and decode Dolby E or Dolby Digital signals, and will pass PCM signals.
Note: In this mode, if the signal is externally switched from a PCM signal to a Dolby-encoded signal, there will be a short burst of noise while the Dolby card detects the new type of signal.
- **Dolby E or Mute:** Selecting this option mutes the Dolby decoder outputs in the absence of a Dolby E bitstream.
- **Dolby Digital or Mute:** Selecting this option mutes the Dolby decoder outputs in the absence of the Dolby Digital bitstream.

Hardware Configuration Menu

Figure 6–9 Hardware Configuration Menu

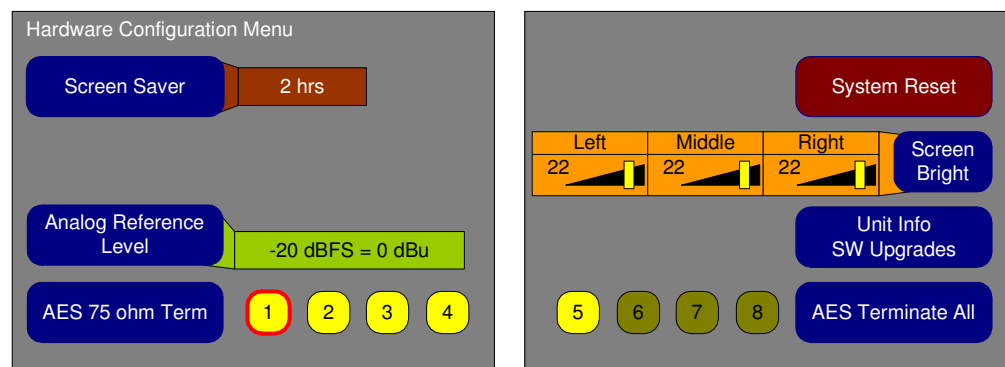

- **Screen Saver:** Pressing this button and then rotating the **Balance** knob allows the user to select from any of the delay times before the screen saver engages:
 - Minutes: 5 minutes to 119 minutes
 - Hours: 2 hours to 24 hours
- **Analog Reference Level:** Pressing this button and then rotating the **Balance** knob allows the user to select from any of the following eight analog I/O reference levels:
 - -22 dBFS = +4 dBu

Chapter 6 Menu List

Hardware Configuration Menu

- -20 dBFS = +4 dBu
 - -18 dBFS = +4 dBu
 - -16 dBFS = +4 dBu
 - -20 dBFS = +8 dBu
 - -20 dBFS = 0 dBu
 - -18 dBFS = 0 dBu
 - -9 dBFS = +6 dBu
- **AES 75 ohm Termination:** Pressing this button and then rotating the Balance knob allows the user to select from any of the eight AES channel pairs shown. Pushing the Balance knob control activates or deactivates the internal 75 ohm termination on each AES input.
 - **System Reset:** Pressing this button allows the user to reset all of the presets and hardware option to the factory standard settings. Before taking effect, a yellow warning diamond appears with a countdown. If the **Balance** knob is not pressed again within five seconds, the request will be canceled. Otherwise, if you press the **Balance** knob within the time-out window, all user presets and other user-configurable settings (such as the unit's Ethernet IP address and mask) will be set to a default state. The unit will then reset, and the default settings will take effect.

WARNING! Pressing this button will erase all of your existing presets. Use with caution.

- **Screen Brightness:** This control allows you to adjust the brightness of each screen individually. Select which screen by repeatedly pressing the button. Turn the **Balance** knob to adjust the brightness. Note that, as with all displays, dimmer settings will result in a longer display life.
- **Unit Info SW Update:** Displays a menu that displays the software version numbers.
- **AES Terminate All:** When pressed, all of the internal 75 ohm AES terminations are activated or deactivated at once.

Label Menu Screen

Figure 6–10 Label Menu

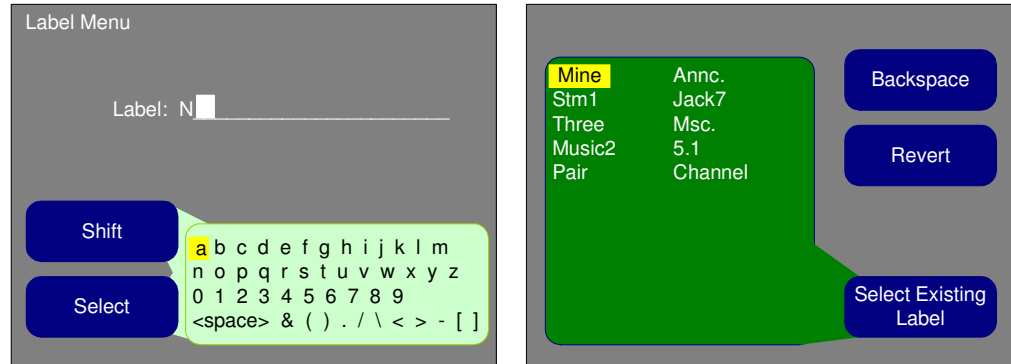

- **Shift:** Pressing the shift control toggles between upper and lower case letters. The letters inside the character selection area of the screen change accordingly.
- **Select Character:** Pressing this button and then rotating the **Balance** knob moves the yellow cursor inside the character field. The cursor wraps to the next line. Pressing the **Balance** knob adds the selected letter, number, or symbol to the label you are creating.
- **Backspace:** A backspace is provided for corrections. Press to backspace.
- **Revert:** This recalls the previous label, and allows you to continue editing.
- **Select Existing Text:** When this screen is entered, the most recently-used label text is displayed. This allows you to start with a similar label, and then use the **Backspace** and/or the **Select** buttons to quickly create a slightly-modified label. For example, this would be useful if you want to create the labels Strm1, Strm2, Strm3, and so on.

Pressing this button and then rotating the **Balance** knob left and right moves the cursor left and right among the labels. The cursor wraps to and from the last label.

Pressing the **Balance** control replaces the label in the label field with the selected label.

Loudness Configuration Menu Screen

This screen has two modes, as shown in Figure 6-11 below. The **Loudness Mode** button selects the mode, and modifies the screen for that mode.

Figure 6-11 Loudness Configuration Menu (Program)

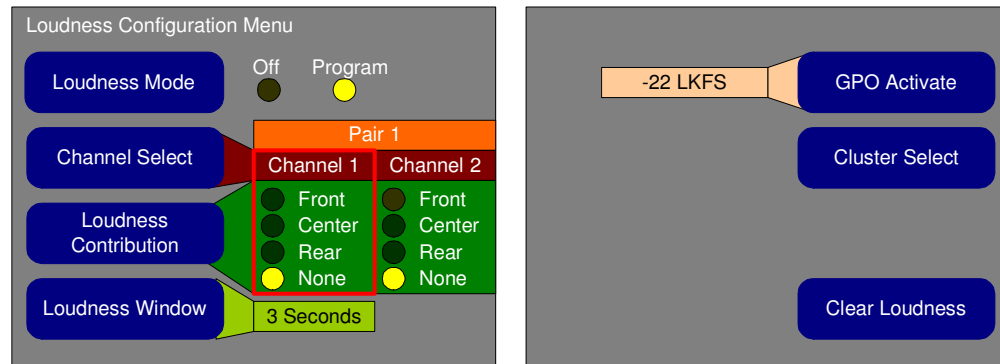

- **Loudness Mode:** Pressing this button alternately turns program loudness mode on or off. You can define a measurement associated with the ITU1770/1771 recommendations. The loudness level is measured in LKFS.
- **Channel Select:** Pressing this button and then rotating the Balance knob control moves the red box from channel to channel. Pushing the control has no effect. The channels scroll left and right as necessary.
- **Loudness Contribution:** Pressing this button and then rotating the Balance knob moves the yellow dot among the radio buttons to select this channel's contribution to the loudness measurement within the contribution fields to allow you to select how the channel contributes to the loudness measurement. When the **Loudness Mode** is **Off** mode, this control doesn't function.

In **Program Loudness Mode**, there is no difference between the contribution of a front channel or a center channel. However, the software will allow you so select, at most, one channel to be designated as a center channel. The software will allow a loudness measurement to be defined with no center channel contribution.

- **Loudness Window:** This control is active only when **Program Loudness Mode** is selected. Pressing this button and then rotating the **Balance** knob adjusts the averaging time between values of 1 second and 60 seconds by one second increments.
- **GPO Activate:** You can use the loudness level to trigger an external function through GPO 1. This control sets the loudness threshold at which GPO1 is activated. Press this button and then rotate the **Balance** knob to select the desired level. In the **Loudness Off** mode, this control doesn't function, and GPO 1 is set to off.
- **Cluster Select:** Loudness may only be displayed for one cluster at a time. Press this button and then rotate the **Balance** knob to select the desired cluster. In the **Loudness Off** mode, this control doesn't function.

If a cluster already has channel contributions assigned, this control is grayed and does not function. To use this control in this case, press the **Clear Loudness** button first. You will then be able to select a different cluster.

Main Screen

The **Main Screen** will appear as shown in [Figure 6-12](#) at power up unless the settings in the **Video Screen Configuration Menu** have been changed.

The **Dolby Pair Indicator** above Pair 6 indicates the pair is a Dolby Encoded signal. The pair will be muted so the noise of the signal doesn't sound in speakers or any other outputs, but the meters will be active. You can follow the instructions in "How Do I Decode and Monitor a Dolby Bitstream" section to monitor this particular signal effectively, if your unit is equipped with a Dolby decoder module.

Figure 6-12 Main Screen

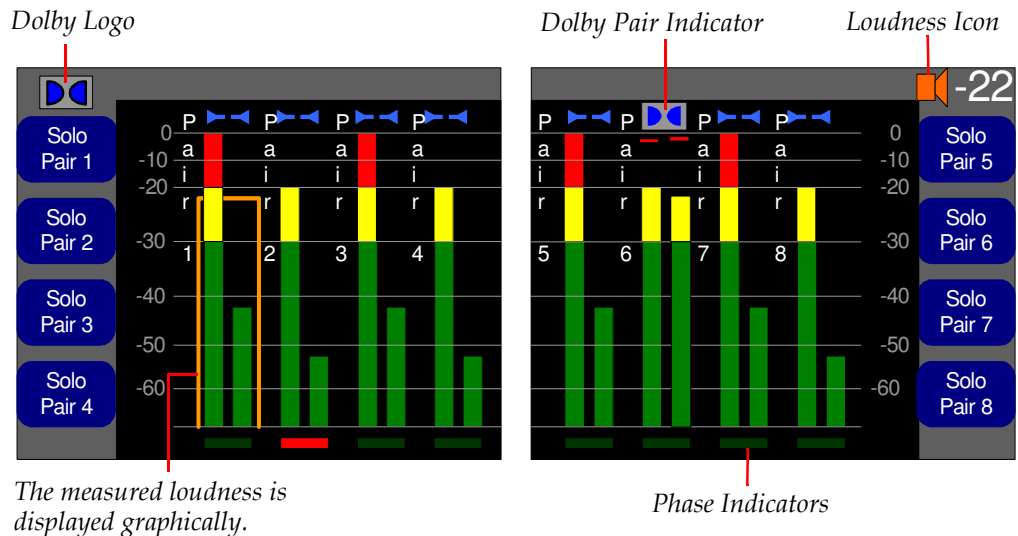

The Dolby Logo will appear above the left side of the meter window if the Dolby decoder module is installed and has a source selected in the **Dolby Setup Menu**.

If it is defined in the **Loudness Configuration Menu**, the measured program loudness displays in LKFS units in the upper right corner of the right-most screen. An orange open bar loudness graph shows the cluster of channels on which the loudness calculation is made.

Buttons 1 - 8: On the **Main Screen Hot Key Configuration Menu**, you can assign these hot key buttons to be presets, solos, or mutes for a programmable set of channels. Table 6-1 below shows the color schemes for each.

Table 6-1 Preset, Solo, and Mute Color Schema

Hot Key	Active Color
Preset	Green
Solo	Blue
Mute	Red
Off	Grey

When you press a solo or mute hot key, the speaker symbol above the corresponding level meter(s) will change to either bright blue or bright red to indicate that the solo or mute function is affecting that channel. If a channel is both soloed and muted, then the mute function overrides. If entered, six-character solo or mute (user-definable) names are visible on the button labels.

Main Screen Hot Key Button Configuration Menu

If a button is configured to be off (non-functional) it will turn gray. With the exception of the preset or off functions, pressing a button is automatically latching/momentary as controlled by the **Options Menu**.

Refer to [Recalling Presets on page 52](#) (in Chapter 4) for different methods of recalling presets.

The phase indicator between channel pairs may be turned off or on in the **Monitor Mixer Configuration Screen**. Meters may be arranged in clusters from the **Cluster Configuration Screen**. Clusters of meters can also receive a label from that menu. The meter scale is user defined through the **Meter Configuration Screen**. The same screen is also used to select meter ballistics and scale and assign the meter color scheme. The **Loudness Configuration Menu** is used to turn on and configure the phase and loudness indicators.

Main Screen Hot Key Button Configuration Menu

Figure 6–13 Main Screen Hot Key Button Configuration Menu

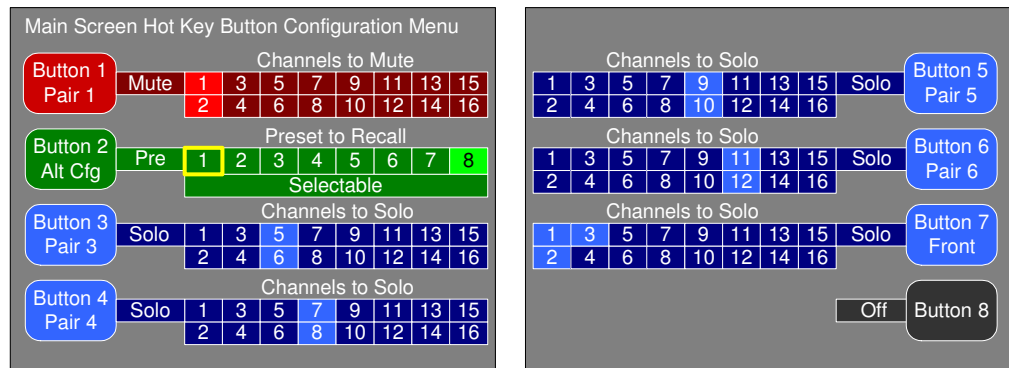

Buttons 1 - 8 – Hot Key Button Configuration: Pressing the button highlights the button label. This highlight can be moved to different elements by rotating the **Balance** knob.

Chapter 6 Menu List
Meter Configuration Menu

- Pressing the **Balance** knob while the highlight is over the button label displays the **Text Entry Menu**. There, you can change the name of the label.
- Pressing the **Balance** knob while the **mute/solo/pre/off** field is highlighted toggles these four option. As each option appears, the color scheme and other elements change as shown in [Figure 6-13](#).
- Pressing the **Balance** knob while a channel is highlighted selects or deselects this channel from the set of solos or mutes applying to this button.
- Pressing the **Balance** knob while a preset is highlighted, selects it and deselects any other preset that was already selected.

Meter Configuration Menu

Figure 6-14 Meter Configuration Menu

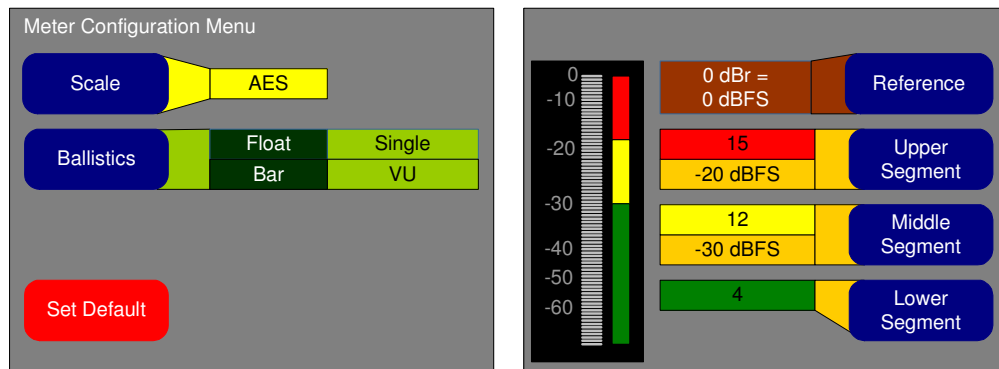

- **Meter Scale:** Rotating the **Balance** knob after pressing this button selects the possible scales for the level meters. Seven selections are available as shown in [Table 6-2](#) below.

Table 6-2 Audio Scale Specification Domains and Defaults

Scale	Volume			Default Color Bounds		Default Ballistics	
	Lower Bound	Upper Bound	Default References	Lower	Upper	Float	Bar
AES	-72 dBFS	0.0 dBFS	0 dBFS = 0 dBFS	-30 dBFS	-20 dBFS	IEC Type I	VU
VU	-45 dBr	+3.5 dBr	-20 dBFS = 0 dBr	-3 dBr	0 dBr	None	VU
Extd VU	-56 dBr	+16.0 dBr	-20 dBFS = 0 dBr	-10 dBr	0 dBr	None	VU

Table 6–2 Audio Scale Specification Domains and Defaults

Scale	Volume			Default Color Bounds		Default Ballistics	
	Lower Bound	Upper Bound	Default References	Lower	Upper	Float	Bar
BBC	-13.25 dBr	+13.0 dBr	-24 dBFS = 0 dBr	0 dBr	8 dBr	None	IEC Type II
EBU	-13.25 dBr	+13.0 dBr	-24 dBFS = 0 dBr	0 dBr	8 dBr	None	IEC Type II
Nordic	-44 dBr	+12.5 dBr	-18 dBFS = 0 dBr	-10 dBr	0 dBr	None	IEC Type I
DIN	-53 dBr	+5.5 dBr	-15 dBFS = 0 dBr	-5 dBr	0 dBr	None	IEC Type I

- **Ballistics:** Rotating the **Balance** knob after pressing this button adjusts the float. Pressing the **Balance** knob and then the rotating the **Balance** knob adjusts the bar. Ballistic timings are valid only at 48 kHz.

Table 6–3 Audio Change Response

Ballistic	Rise		Fall	
	Level Change	Time	Level Change	Time
VU	Not Specified			
IEC Type I	-2 dB of settled reading	5 ms	-20 dB	1.7 sec.
IEC Type II		10 ms	-24 dB	2.8 sec.
None	Bar or Floating Segment Not Displayed			

- **Set Default:** Press this button and then confirm by pressing the **Balance** knob.
- **Reference:** Rotating the **Balance** knob after pressing this button adjusts the display reference level. The reference level is adjustable in one dB increments.
- **Upper Segment Color:** Rotating the **Balance** knob after pressing this button cycles the upper color of the displayed sample level meter color through a wide variety of colors. Pressing the **Balance** knob and then the rotating it sets the division between the upper and middle segments. Color boundaries are adjustable in 1 dB increments, and have the same range as the top and bottom limits of the meter.
- **Middle Segment Color:** Rotating the **Balance** knob after pressing this button cycles the middle color of the displayed sample level meter color through a wide variety of colors. Pressing the **Balance** knob and then the rotating it sets the division between the middle and lower segments. Color boundaries are adjustable in one dB increments, and have the same range as the top and bottom limits of the meter.

Chapter 6 Menu List

Monitor Mixer Configuration Menu

- **Lower Display Color:** Rotating the **Balance** knob after pressing this button cycles the lower color of the displayed sample level meter color through a wide variety of colors.

Monitor Mixer Configuration Menu

Figure 6–15 Monitor Mixer Configuration Menu

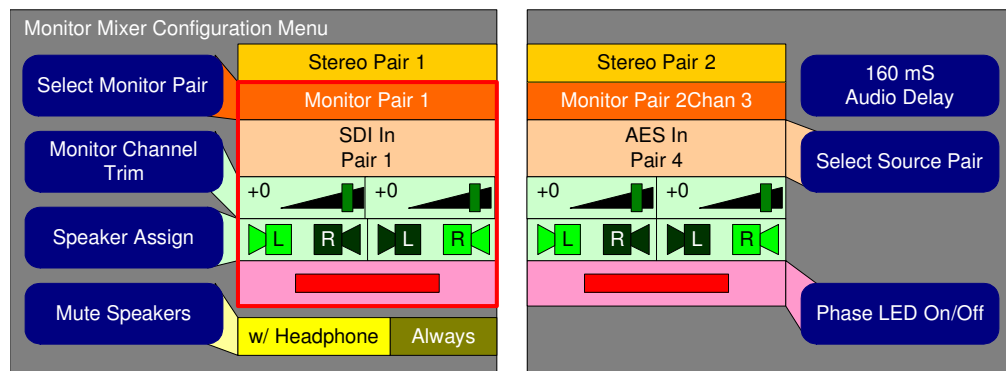

This menu allows you to control the channels to be monitored, how each channel is monitored, and the phase displays for each channel. At the top of each channel, the cluster to which it belongs is displayed.

Channels may also be visible without having to be audible but the reverse is not true.

- **Select Monitor Pair:** Pressing this control and then rotating the **Balance** knob moves the red selection box from side to side, selecting the channel pair to configure. Note that the eight pairs (16 channels) will scroll on and off the screen as you rotate the knob.
- **Monitor Channel Trim:** Pressing this control selects the left, the right, or both volume controls in the selected pair. Selection is indicated by the blinking handle. Rotating the **Balance** knob changes the gain. The change is indicated both graphically and numerically.

Pressing the **Balance** control knob returns the channel to unity gain. This control has a range of -60 dB to +12 dB (inclusive) in one dB steps.

- **Speaker Assign:** This button directs audio from the channel to the left, right, or both speakers. Pressing this button and then rotating the **Balance** control knob moves the red highlight around the speaker symbols. Pressing the **Balance** knob toggles the speaker symbol active (bright green) or inactive (dark green).
- **Mute Speakers:** This sets whether the speakers are muted by plugging in the headphones. Pressing this button and then pressing or rotating the **Balance** control knob toggles the selection between **With Headphone** or **Always**.
- **Audio Delay:** Pressing this button and then rotating the **Balance** control knob changes the global audio delay. The range is 0 to 170 mS in 1 mS increments. The actual audio delay to the monitor speakers changes dynamically as this control is turned.
- **Select Source Pair:** Pressing this button and then rotating the **Balance** knob takes you through all the possible AES and SDI channel pair sources.

You can choose any one of the available channel pairs of the active SDI input card, one of the eight channel pairs of the AES input, or **Off**. In a unit with Dolby enabled, the five decoded output channel pairs are added. The choices are presented to you as **SDI Pair y** or **AES Pair y** or **Dolby Pair y**.

- **Phase LED On/Off:** Pressing this control turns the selected phase indicator on (bright red) or off (dark red) and enables/disables the appearance of the phase indicator on the **Main Screen**.

Option Configuration Menu

Figure 6–16 Option Configuration Menu

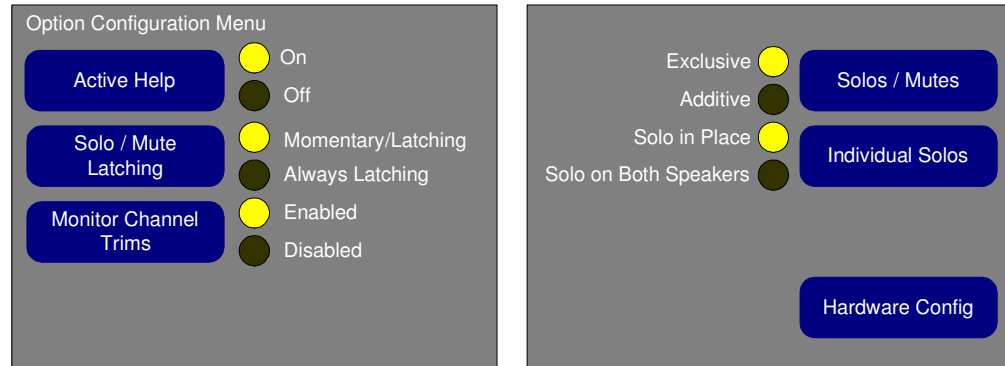

- **Active Help:** When pressed, this control selects whether the **Active Help** will appear on the left-hand screen whenever the setup menus are being used.
- **Solo / Mute Latching:** When pressed, this control selects whether the action of the solo and mute hot keys is automatically momentary or latching, or whether they will always be latching and never momentary. This control setting also applies to the eight GPI inputs which activate the hot key functions.
- **Monitor Channel Trims:** Pressing this button determines whether you can adjust the **Monitor Channel Trim** controls on the **Monitor Configuration Menu**, **AES Output Configuration Menu**, and the **Analog Output Configuration Menu**. When this is enabled, the values set on the trims in these menus will be frozen.
- **Solos/Mutes:** Pressing this button determines whether you can select more than one solo or mute hot key at a time on the **Main Screen**.
- **Individual Solos:** Pressing this button toggles the action of solo hot keys on the **Main Screen** between soloing in place (left or right) or soloing on both speakers.
- **Hardware Configuration Menu:** Pressing this button displays the **Hardware Configuration Menu**. (See [Hardware Configuration Menu on page 75](#) and Chapter 7 for details.)

Preset Management Menu

When you enter this menu, all of the controls are set to affect the most recently recalled preset number.

Note: When exiting this menu, be sure to use the ✓ button. Otherwise, all the changes you made in this menu will be ignored, and all the presets will revert to their former state.

Note: For instructions for copying the presets from one AMP1-16 Series monitor to another, refer to [Copying Presets to Another Monitor on page 58](#).

Figure 6–17 Preset Management Menu

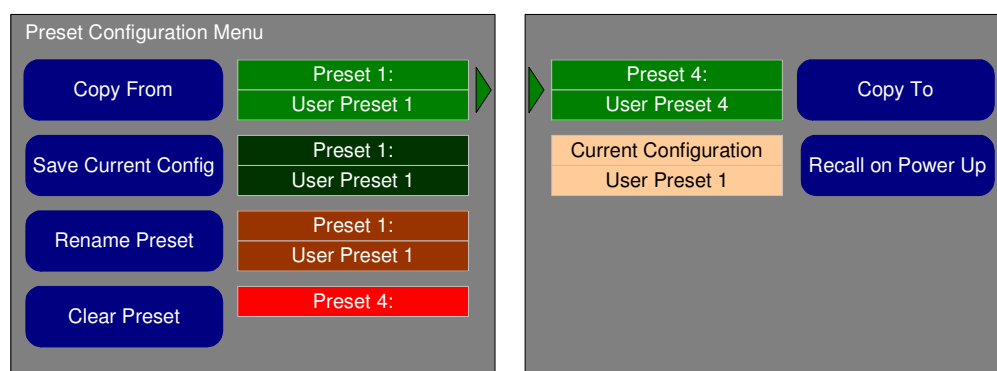

- **Copy From:** Pressing this button and then rotating the **Balance** knob selects the source preset for the copy.
 - Note:** You should set both the **Copy From** and the **Copy To** fields before pressing the **Balance** knob to execute the copy.
- **Save Current Config:** Press this button and then rotate the balance knob to select one of the eight presets to hold the current configuration of the unit. Press the balance control to confirm your selection. The label menu will then appear, where you may enter a new name for this preset.
 - Note:** This operation replaces all settings previously stored in the selected preset.
- **Rename Preset:** Pressing this button and then rotating the **Balance** knob allows you to select from any of the eight presets. Pressing the **Balance** knob proceeds to a text entry menu to select a new name for the Preset.

Chapter 6 Menu List

Screen Display Menu

- **Clear Preset:** Pressing this button and then rotating the **Balance** knob allows you to select from any of the presets. Press the **Balance** knob to erase the preset. A warning diamond will appear with a five second countdown. To confirm the preset erasure, press the balance knob again. Otherwise, wait until the warning diamond time expires.
- **Copy To:** Pressing this button and then rotating the **Balance** knob selects which preset is the destination for the copy.
 - Note:** You should set both the **Copy From** and the **Copy To** fields before pressing the **Balance** knob is pressed to execute the copy.
- **Recall on Power Up:** Pressing this button and then rotating the **Balance** knob allows you is to select from any of the presets, plus the last known state of the unit. Thus, on a power failure, or when the unit is unplugged, the unit can either start up in its last known state, or in any preset.

Screen Display Menu

Figure 6–18 Screen Display Menu

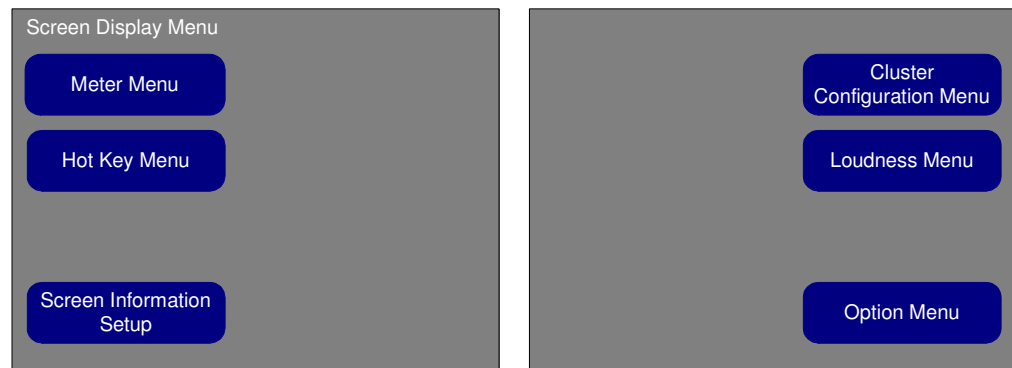

- **Meter Menu:** Displays the **Meter Configuration Menu** so you can set up metering and display parameters.
- **Hot Key Menu:** Displays the **Main Screen Hot Key Configuration Menu** so you can use to set up the function of each of the eight hot keys on the **Main Screen**.

- **Screen Information Menu:** Displays **Screen Information Setup Menu** so you can set up and display a variety of parameters for the video screen.
- **Cluster Configuration Menu:** Displays the **Cluster Configuration Menu** so you can set up and name meter clusters.
- **Loudness Menu:** Displays the **Loudness Configuration Menu** so you can set up parameters that affect the measurement of loudness.
- **Option Menu:** Displays the **Option Menu** so you can set up parameters relative to miscellaneous options and preferences, as well as access the hardware configuration and upgrade software. (See [Option Configuration Menu on page 86](#) and Chapter 7 for details.)

Screen Information Setup Menu

Figure 6-19 below shows some of the metadata that can be displayed on the screens of the AMP1-16. The Dolby Decoder supplies all but one of the metadata parameters. The exception is the video mode, which is determined by the signal present at the selected SDI input.

Metadata parameters that are not available when the main screen is displayed are given the value N/A.

Figure 6-19 Screen Information Setup Menu

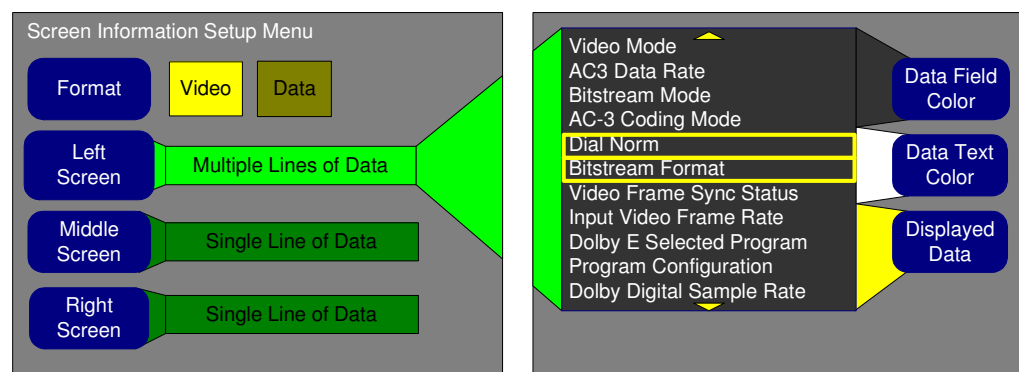

- **Format:** Pressing this button moves the highlight between the two possible screen formats:

Screen Information Setup Menu

- Video image
- Data list
- **Left Screen:** Pressing this button selects the left screen to be set up with the **Displayed Data** and **Data Text Color** buttons. Multiple data items can be displayed on the left screen.
- **Middle Screen:** Pressing this button selects the middle screen to be set up with the **Displayed Data** button. Multiple data items can be displayed on the left screen. Only one data item can be displayed at a time on the middle screen.
- **Right Screen:** Pressing this button selects the right screen to be set up with the **Displayed Data** button. Multiple data items can be displayed on the left screen. Only one data item can be displayed at a time on the right screen.
- **Data Field Color:** This button is disabled unless the Left Screen button is pressed. Rotating the **Balance** knob after pressing this button cycles the color of the data field background through a wide variety of colors. This is displayed in the tab at the left and in the background field of the data line.
- **Data Text Color:** This button is disabled unless one of the three screen buttons is pressed. Rotating the **Balance** knob after pressing the **Left Screen** button cycles the color of the data text through a wide variety of colors. This is displayed in the tab at the left and in the text of the data line.
- **Displayed Data:** This button is disabled unless one of the three screen buttons is pressed. When pressed, rotating the **Balance** knob highlights consecutive items in the list. Pressing the **Balance** knob adds an item to the selected screen. Pressing the **Balance** knob on data that is already added to the data line will remove it from the data line.

The available data that can be selected is:

- Bitstream Format
- Program Configuration
- Frame Rate
- Program ID
- Bitstream Mode

- Coding Mode
- Center Mix Level
- Surround Mix Level
- Surround Mode
- Low Frequency Effect
- Dialogue Normalization
- Video Mode
- Data Rate

Unit Information Menu

Figure 6–20 Unit Information Menu - Initial Display

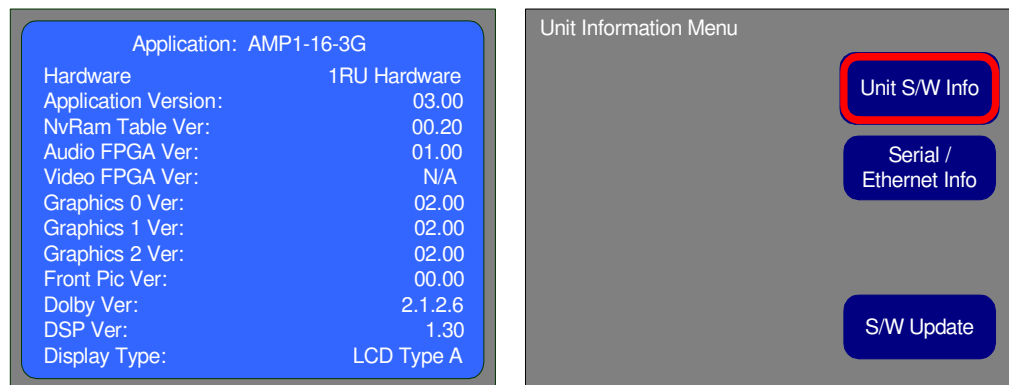

- **Unit S/W Info.:** When pressed, this displays the version of each software element in the product. It also displays the audio processor cards that are present in the monitor. This is the information that appears when you first enter the **Unit Information Menu**.
- **Serial / Ethernet Info:** Pressing this button changes this menu to show the following information relating to the ethernet and serial ports as shown in the following:

Figure 6–21 Unit Information Menu - Ethernet and Serial Port Configuration

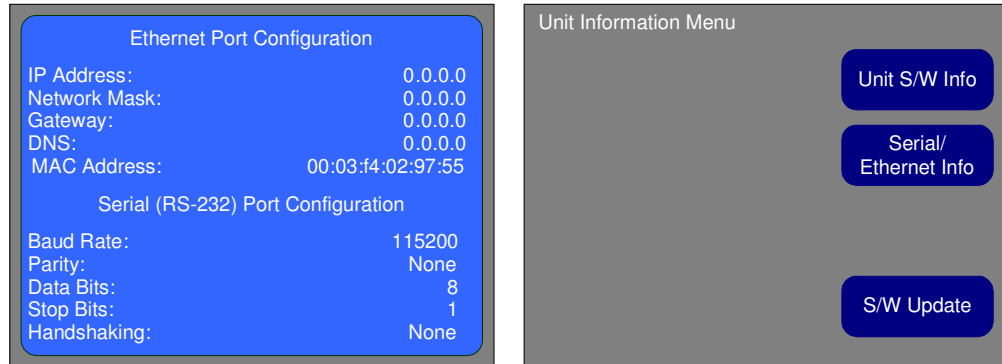

- **ENABLE FTP:** This button label only appears when the **S/W Update** menu is selected, as in Figure 6–22. It is used as part of the software update procedure.
- **S/W Update:** Press this button to begin the software update process. Instructions then appear on the screen as follows:

Figure 6–22 Unit Information Menu - Software Update Instructions

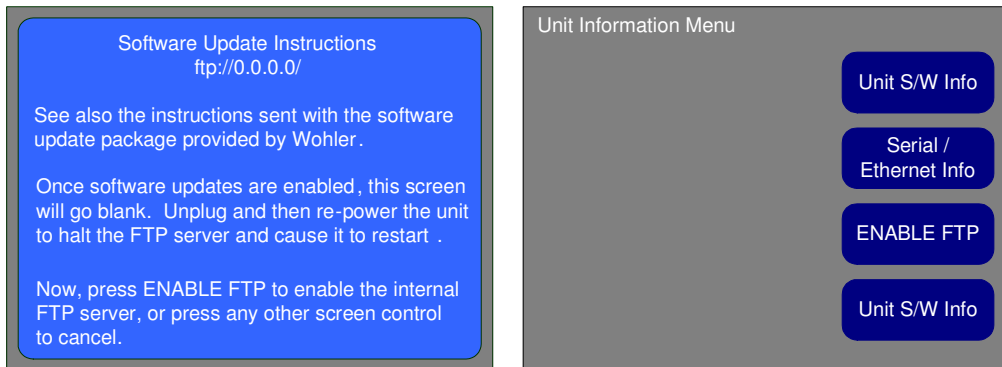

CHAPTER 7

Firmware Updates

Introduction

Overview

This chapter describes how to establish an Ethernet connection between a host computer and an AMP1-16V, and then how to update the AMP1-16V's firmware through that Ethernet connection. These steps will be described in detail in the following Topics:

Note: It may prove useful to reprint this chapter every time you need to perform an upgrade, since several sections provide space to record existing settings.

Topics

Topics	Page
Introduction	93
Upgrade Requirements	94
Comparing Firmware Versions	94
Upgrading the Netburner Software	96
Upgrading the Sub-Processor Firmware	98

Upgrade Requirements

- A host computer running Windows XP Professional, with Service Pack 3 installed. Other operating systems may work, but are not described in detail here.
- Download the latest update package available from the Downloads tab in the AMP1-E16V-MD section of the Wohler website (www.wohler.com). Once downloaded, be sure to unzip the update package to a convenient location on the host computer, such as the Desktop.
- Check the Readme file in the update package for any additional upgrade requirements.
- A Local Area Network (LAN) to which both the host computer and the units are connected with standard Ethernet patch cables, or a “crossover” cable to connect the host computer directly to the AMP1-16V. **Using the LAN and DHCP is the preferred method.**

Comparing Firmware Versions

1. Access the AMP1-16V's **Unit Information Menu**. From the **Main Screen**, press the checkmark button to get to the **Configuration Selection Menu**. Then follow this menu navigation: **Screen Display Menu -> Option Menu -> Hardware Config -> Unit Info SW Upgrades**. The following screen should now be displayed:

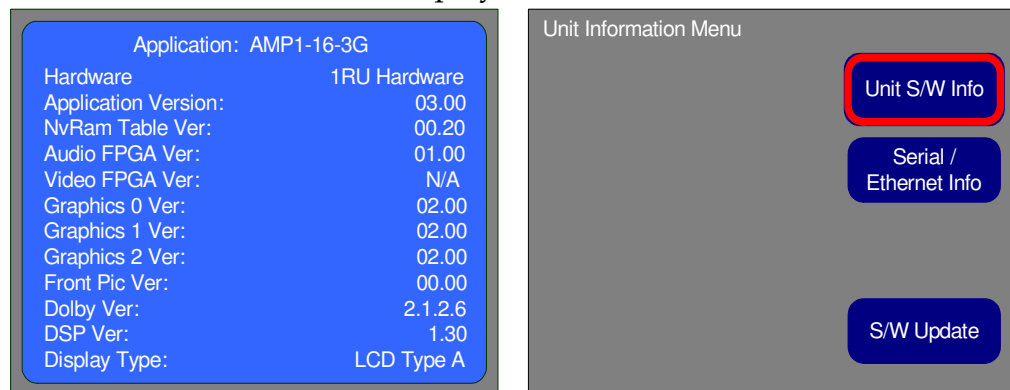

2. If you haven't already, unzip the update package downloaded from the Wohler website. Open the S19 Files folder in the package. It should look similar to this:

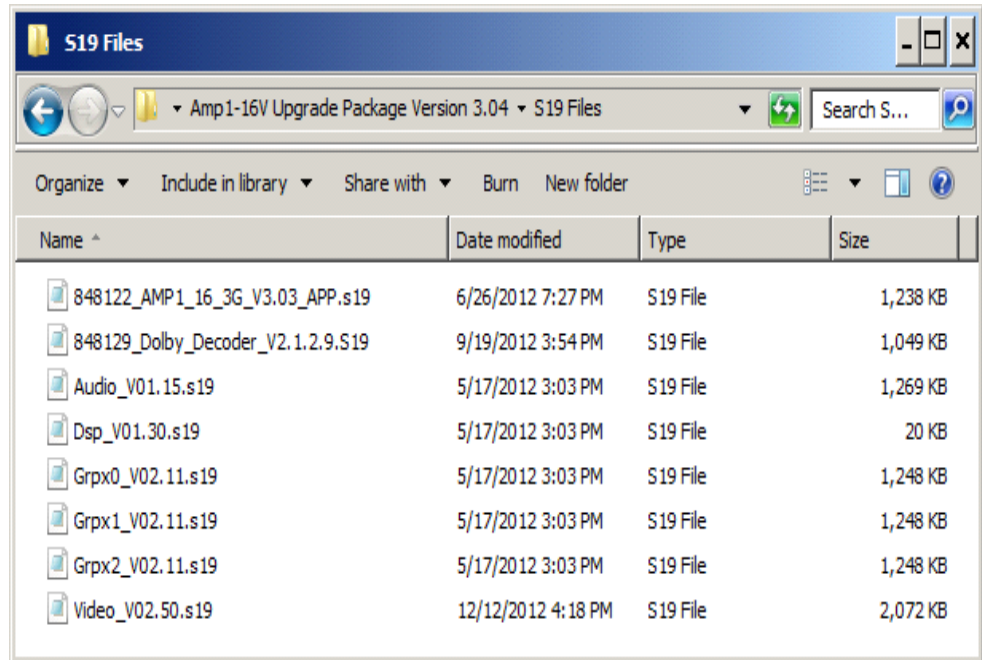

3. Compare the versions in the S19 Files folder to the versions shown on the screen of the AMP1-16V. Note any versions that are out of date in the lines below. The AMP1-16V cannot report its video FPGA version. If you are doing any other updates, please include the video FPGA as well:

- Audio_Vxx.xx.S19 _____
- Video_Vxx.xx.S19 (can't compare, see above.)
- Dolby_Vx.x.x.x.S19 _____
- Grpx0_Vxx.xx.S19 _____
- Grpx1_Vxx.xx.S19 _____
- Grpx2_Vxx.xx.S19 _____
- DSP_Vxx.xx.S19 _____

Upgrading the Netburner Software

Refer to Appendix A to establish a connection between the host computer and the AMP1-16V.

Decision Point:

If the Application version is current as noted in Step 3 above, in the Comparing Firmware Versions section, you may skip to the next section.

Otherwise, continue with this section.

1. Launch the **NetBurner AutoUpdate** utility found in the update package in the Utilities Folder. Click on the **Find** button. You should see something similar to [Figure 7-1](#) below.

Figure 7-1 Find Netburners Dialog

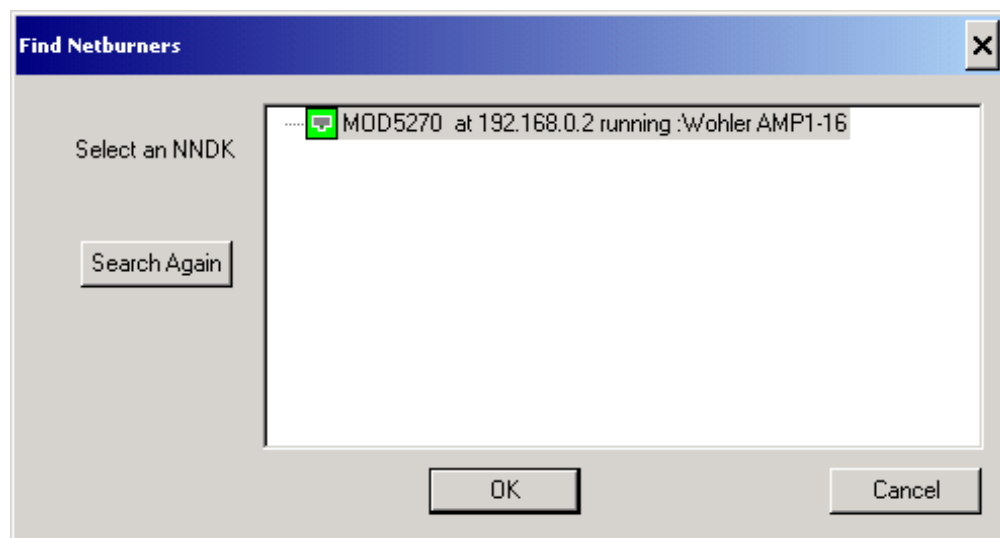

2. Click to highlight the NetBurner module you want to update, and click **OK**.

Figure 7-2 AutoUpdate IP Address Input Dialog - Incomplete

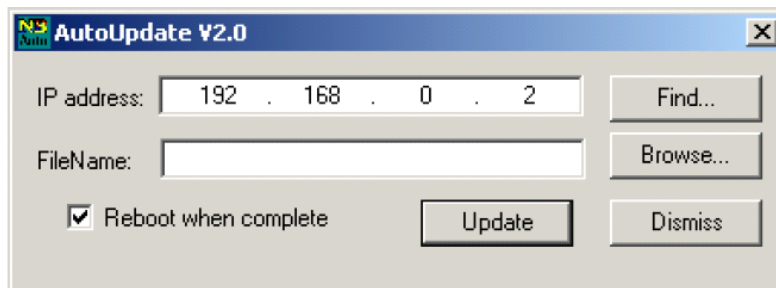

3. Click **Browse** and locate the **AMP1_16_Vx.xx_APP.s19** file in the S19 Files folder of the update package. (The x's will be replaced with the software version.)

Write the IP Address here: _____.

4. Check the **Reboot when complete** check box. The **Autoupdate** dialog box should look like the one in [Figure 7-3](#) below.

Figure 7-3 AutoUpdate IP Address Input Dialog - Complete

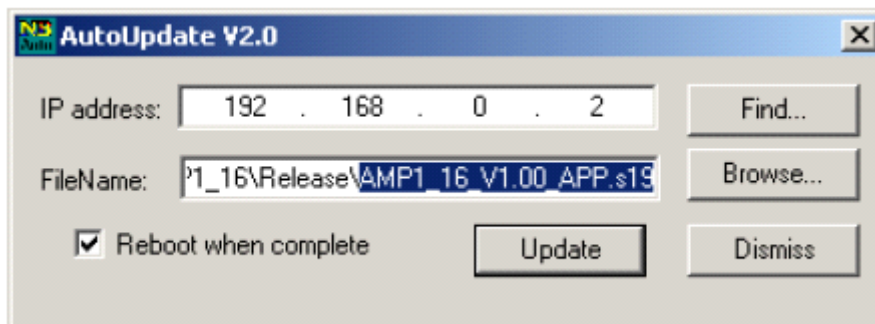

5. Press the **Update** button on the dialog in [Figure 7-3](#).

Figure 7-4 Autoupdate Confirmation Dialog

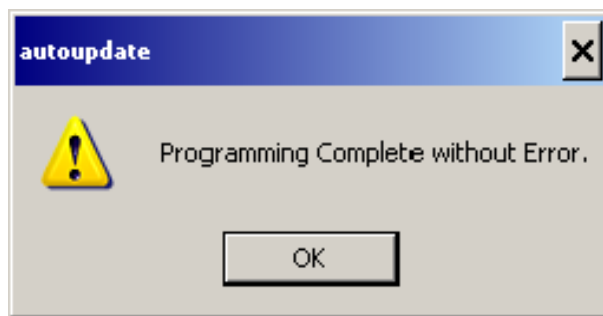

6. Click **OK** and both the dialog box and the **AutoUpdate** utility will close, and the unit will reboot and run the new software.

Upgrading the Sub-Processor Firmware

Note: If the screens remain dark after updating the Netburner firmware, the unit will enter FTP mode automatically. You may skip Steps 1-4 below.

1. Power the AMP1-16V and navigate to its **Unit Information Menu**. From the Main Screen, press the checkmark button to get to the **Configuration Selection Menu**. Then follow this menu navigation: **Screen Display Menu -> Option Menu -> Hardware Config -> Unit Info SW Upgrades**. It will appear as shown in [Figure 7-5](#) below.

Figure 7–5 Unit Information Menu

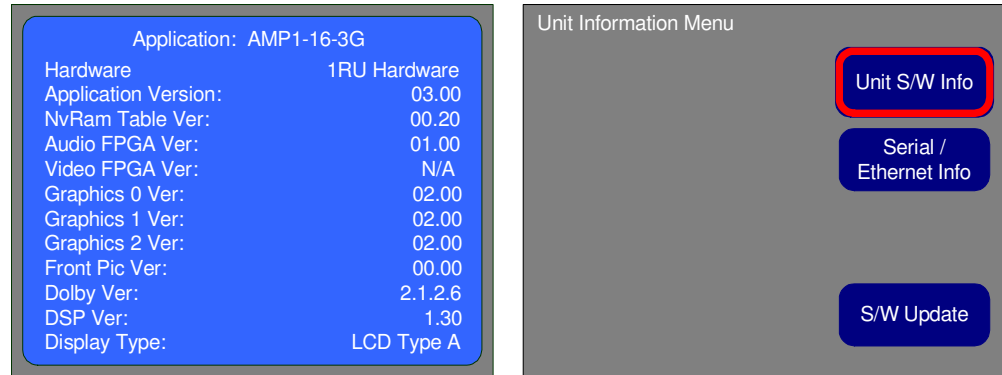

2. When the **Unit Information Menu** appears, press the **S/W Update** button.
3. Note the line of text at the top of the window with the FTP address. It should read something like <ftp://192.168.0.2/>

Important: If the address comes up as <ftp://0.0.0.0/>, the unit is using DHCP in a direct connection, or no Ethernet connection exists. See [Connecting to a LAN](#) on page 114.

Write it here _____.

4. On the monitor, press the **ENABLE FTP** button.
5. Open **My Computer** from the Windows desktop or from the “Start” menu.
6. In the **Address** line, enter the address you wrote down in Step 3 (in the previous section), exactly as noted. For example, enter <ftp://192.168.0.2/>.
7. You will see something similar to the following screen shot in [Figure 7-6](#), if the folders are set to detail view. The filename, folder name, and file sizes below are accurate. All other attribute information, especially the dates, are bogus and should be ignored.

Chapter 7 Firmware Updates

Upgrading the Sub-Processor Firmware

Figure 7-6 FTP Location

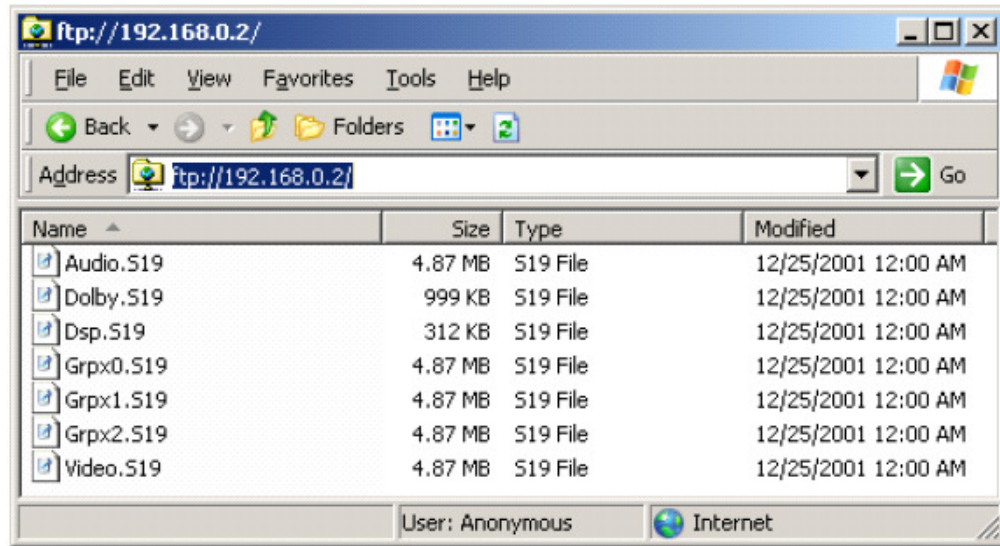

8. If you see the following dialog similar to the one in Figure 7-7 after a minute or so, it means the FTP connection failed. Try power cycling the AMP1-16V, and restarting the host computer. Then repeat the steps above. When you get back to this point, press the F5 key to refresh the window.

If the AMP1-16V does not respond to the FTP address you enter, you may recheck the FTP address by rebooting the machine and returning to the Ethernet configuration menu, or by using the IP Setup Utility's **Find** button.

Figure 7-7 Failed FTP Connection

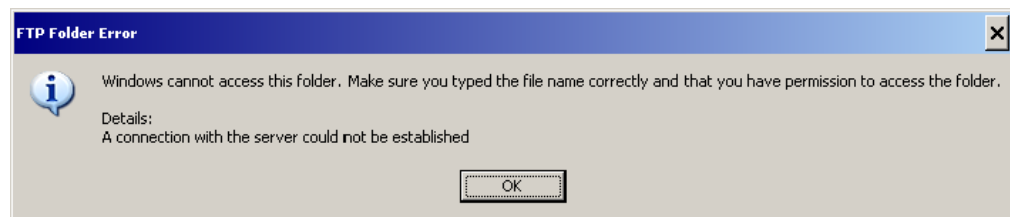
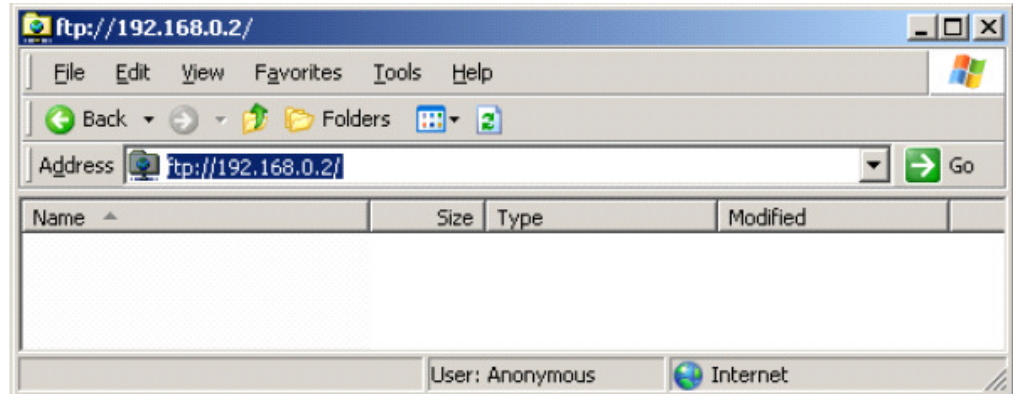

Figure 7–8 FTP Window



9. Press the F5 key to refresh the window.

Important: You must refresh the file window after each of the following steps since Windows caches the file and folder information. If any of the files change, Windows will report the previous information from its cache rather than the current information. Refreshing the folder after each file change resolves this issue.

10. From here on, drag and drop files from where they are stored on the local host to the unit's FTP window.

Important: Program **ONLY ONE DEVICE AT A TIME**. Windows will allow you to drag and drop multiple files, but the FTP server in the unit **cannot** handle this. In addition, the files in the unit are write-only so they cannot be read. In all other respects, the FTP window can be treated like any other file or folder window.

Chapter 7 Firmware Updates Upgrading the Sub-Processor Firmware

Figure 7-9 File Transfer

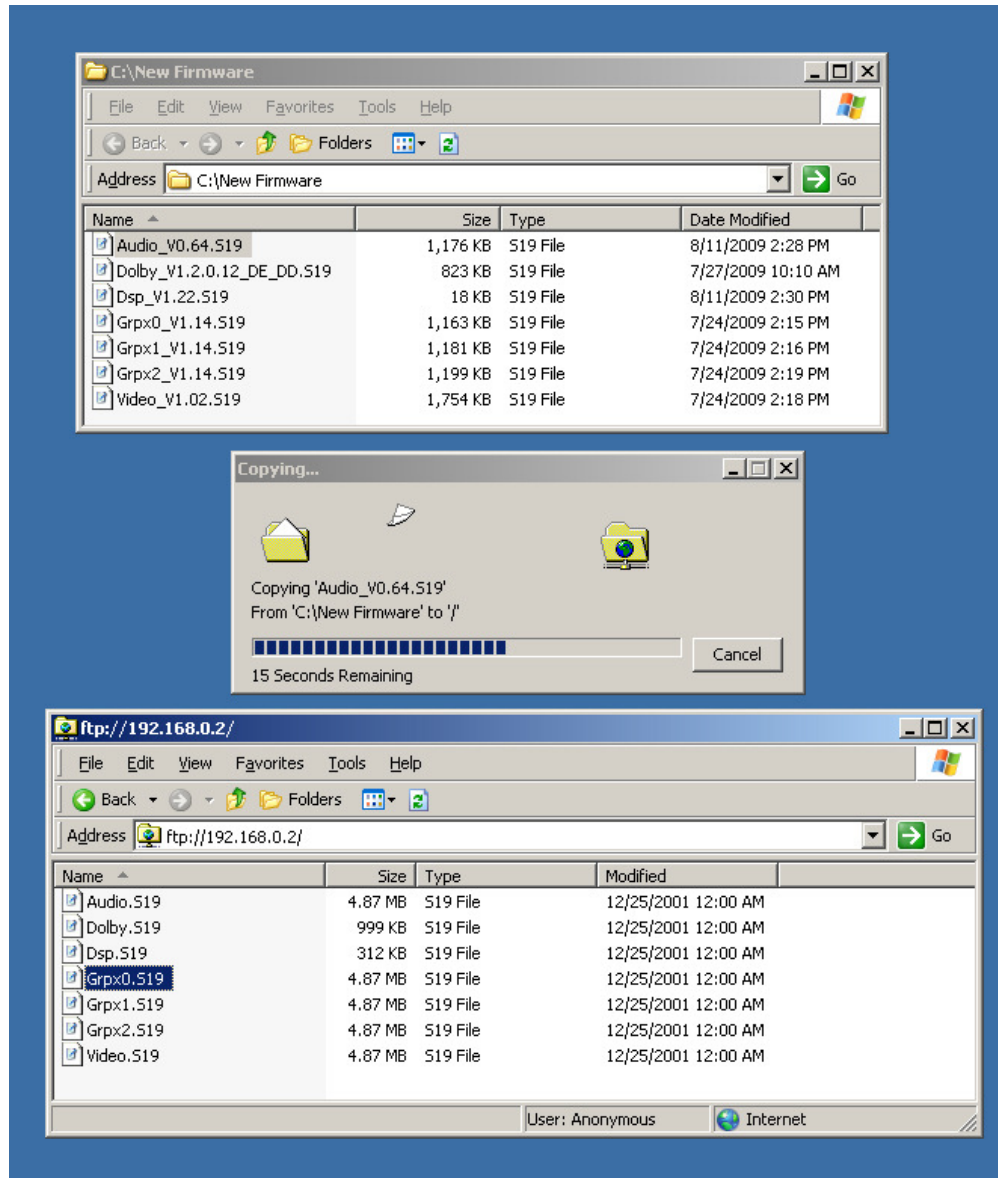
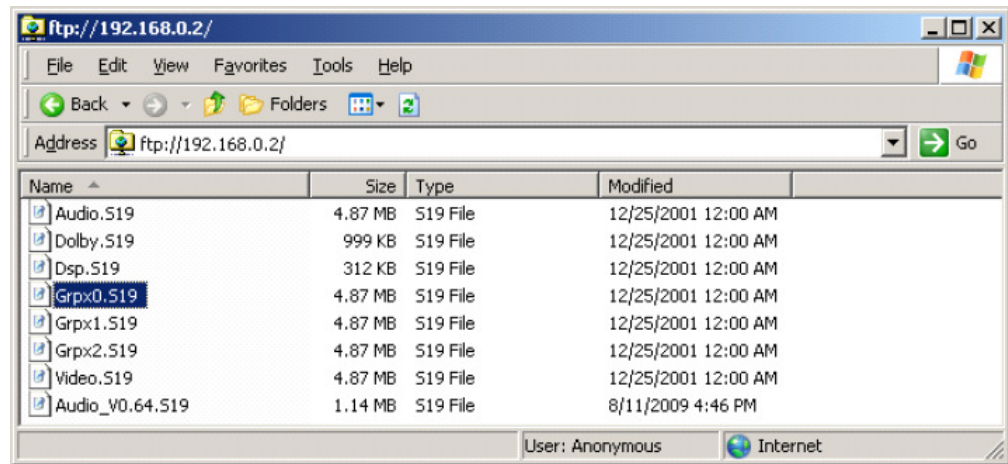

Figure 7-7 above shows a sub-processor being programmed.

Figure 7-10 Copy Completed



11. Once an sub-processor has been reprogrammed, wait about 15 seconds, and press F5 to refresh the window. The window will now appear like the one shown in Figure 7-11.

Figure 7-11 Refreshed Window

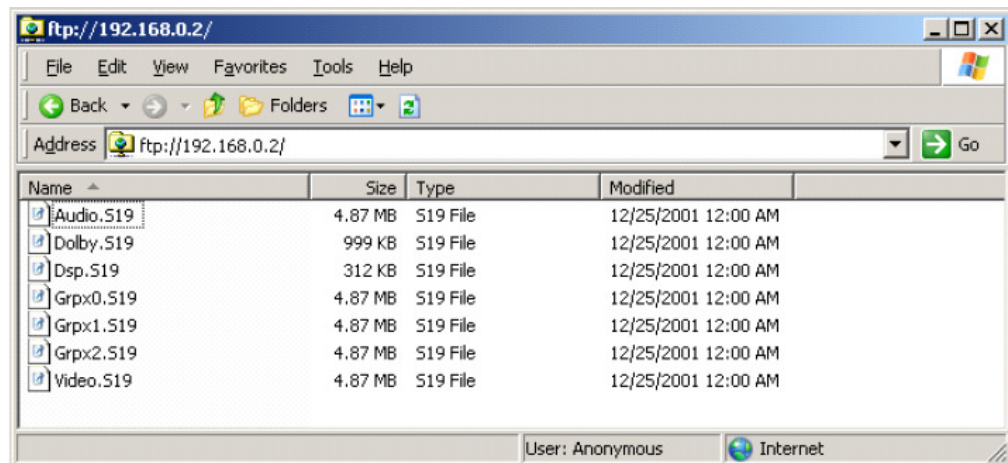

12. When all the sub-processors have been reprogrammed, cycle the power on the unit by unplugging and re-plugging the power cord.

Important: This concludes the upgrade procedures for both the NetBurner and the sub-processors.

Chapter 7 Firmware Updates

Upgrading the Sub-Processor Firmware

CHAPTER 8

Features and Specifications

Introduction

Overview

This chapter lists the features and specifications of the AMP1-16V-MD and AMP1-E16V-MD.

Topics

Topics	Page
Introduction	105
Features	106
Specifications	108

Features

Product Benefits

- Monitoring of up to 16 channels of embedded audio in a single, multirate SDI signal can be used in the most complex, multi-channel and surround applications.
- Automatic detection and indication of Dolby encoded signals (E, D, and D+) are shown in the main screen.
- The totally digital system architecture with high fidelity, class D amp provides reproduction of the embedded signal with unsurpassed fidelity in a near field audio monitor.
- You can assign any channel on any input to the left or right speaker. Production tools and needs for monitoring can vary from job to job, so these units provide optimum flexibility in directional signal monitoring, allowing you to configure the system to your needs for any given production.
- Near field audio monitors are often placed in a signal path. The re-clocked output of the SDI signal and demux outputs for eight AES pairs (on unbalanced 75Ω BNC connectors) provide cost savings in signal chain management, with the precision required for a digital infrastructure.
- You can create and store eight user-defined presets for quick configuration changes.
- DTV programming requires absolute adherence to standards and requirements. Crucial elements of the audio signal (such as loudness and dial norm) are constantly sampled and instantly displayed on the video screen to prompt operators to take appropriate measures.
- Production facilities and outside broadcast (OB) operators provide programming for clients on a global basis. Program producer and networks metering standards can be instantly accommodated with metering resolution (180 segments displayed with stereo phase indicators for stereo pairs) that is unmatched in precision. User selectable meter:
 - Scale

- Color thresholds
- Ballistics

Distinction Between Models

The Dolby CAT552 hardware is included in the AMP1-E16V-MD, making it the first 1RU Wohler audio monitor with Dolby E, D, and Dolby Digital Plus built in.

By contrast, the AMP1-16V-MD must have an additional hardware add-on installed before both the Dolby D and Dolby E protocols are available. Note that when the Dolby module is installed, and has a source selected in the **Dolby Setup Menu**.

Additional Features

- 1RU case for space savings
- 1/8" (3.5 mm) stereo front panel headphone jack
- Dual selectable 3G/HD/SD-SDI inputs
- Fixed or variable room surround monitoring outputs
 - Eight Unbalanced AES pairs on HD15 x 2
 - Four balanced line level analog audio pairs on DB25
- Multipurpose GPIO:
 - Eight GPI inputs with common ground, which replicate the action of the eight front panel hot keys surrounding the display.
 - Two isolated Form C outputs, one of which activates when the loudness is above a programmable level.
- Automatic Dolby E, D, or DD+ or AES Bitstream detect
- Stereo phase indicator is present for each stereo input source monitored. Stereo phase indication occurs in adjacent channels in the signal chain before routing to speakers.
- 100 to 240 VAC ($\pm 10\%$) operation with a self-contained power supply.

Compliance

All components comply with UL, CE, and RoHs specifications.

Standards

Loudness measurements comply with ITU-1770/1771 standards.

Specifications

Table 8-1 Specifications

Specification	Values/Domains
Power requirements	100 V to 240 V AC \pm 10%, 50/60Hz
Power consumption	65 Watts
Dimensions (H x W x D)	1.75" x 19" x 11" (4.5mm x 483mm x 30mm)
Weight	10.05 lbs.
Space Required	1 RU (rack unit)
Supplied Accessories	AC Power Cord (North America)
Optional Accessories	Dolby card
Display Type	TFT LCD
Native Aspect Ratio	4:3
Number of Displays	3
Active Viewing Area	2.4" diagonal per screen
Screen Resolution	320 x 240
Inputs	<ul style="list-style-type: none">• AES/EBU: 8 unbalanced on BNC• SDI: 2 3G/HD/SD-SDI on BNC

Table 8-1 Specifications (Continued)

Specification	Values/Domains
Outputs	Configurable Outputs: <ul style="list-style-type: none"> • AES/EBU output 8 unbalanced on high density DB-15 • Analog: 8 balanced channels configurable on DB25 • SDI: 1 reclocked on BNC Analog Output: <ul style="list-style-type: none"> • Maximum: +24dBu • Noise: -72dBu • Analog Dynamic Range: 96dB @ 20 to 20kHz
Level Meters	180 segments
Level Meter Scales	Selectable: <ul style="list-style-type: none"> • AES, • VU, • Ext. VU, • BBC, • EBU, • Nordic, and • DIN
Level Meter Characteristics	Selectable: <ul style="list-style-type: none"> • Meter thresholds, • Reference, • Segment Colors, and • Ballistics
Peak Acoustic Output	98dB SPL (@ 2 feet)
Power Output	Tweeters: 5W RMS Continuous into 8 ohms, each side, 10W Transient Woofers: 4W RMS Continuous into 4 ohms, each side, 17W Transient
Acoustic Frequency Response	80Hz - 20kHz (±5dB) (-10dB @ 50Hz, 22kHz)

Table 8-1 Specifications (Continued)

Specification	Values/Domains
AES/EBU Input Termination	75 Ω unbalanced, switchable
SDI Input Termination	75 Ω unbalanced
AES/EBU Input Sampling Rate	32-48kHz, Auto-detecting
Hum and Noise	Better than -68dB below full output
Electrical Distortion	<0.15% at any level below limit threshold
Acoustic Distortion	8% or less worst case frequencies above 180Hz
Magnetic Shielding	<0.5 gauss any adjacent surface

Table 8-2 Video Formats

Standard	Format
SD	525i 59.94
	625i 50
HD	720p 50
	720p 59.94
	720p 60
	1035i 59.94
	1035i 60
	1080i 50
	1080i 59.94
	1080i 60
	1080sf 25
	1080sf 29.97
	1080sf 30
3G	1080p 50
	1080p 59.94
	1080p 60

Technical Functional Overview

Figure 8-1 on page 111 illustrates the overall functionality of the AMP1-16 Series monitors.

Figure 8-1 AMP1-16 Block Diagram

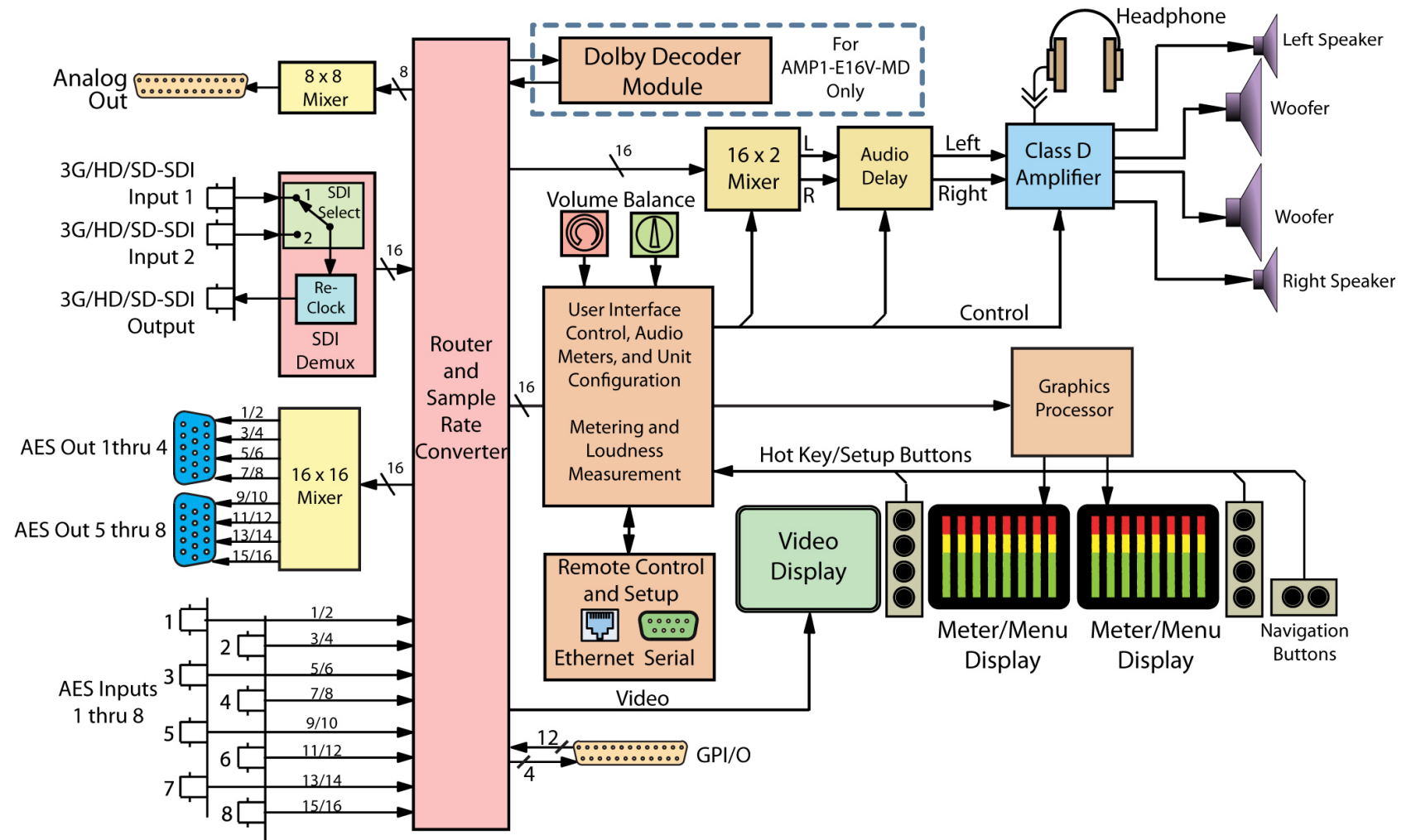

APPENDIX 9

Establishing Connectivity

Introduction

Overview

This appendix explains how to establish an Ethernet link between a Windows host computer and an AMP1-16V by two different methods. Either method may be used.

Topics

Topics	Page
Introduction	113
Connectivity Options	114
Connecting to a LAN	114
Connecting Directly	117
Setting a Static IP in the AMP1-16V	120
Setting a Static IP in a Windows XP Computer	121
Setting a Static IP in a Windows 7 Computer	126

Connectivity Options

The fastest and simplest way to establish connectivity to your AMP1-16V-MD Series monitor is through a LAN (local area network) that includes a DHCP server, which will provide Ethernet settings for both the host computer and the AMP1-16V automatically. The alternative is to set up a direct connection between the host computer and the unit through a crossover cable.

Decision Point:

The following section describes connecting through a LAN. If you wish to connect directly, please skip to [Connecting Directly on page 117](#).

Connecting to a LAN

Launching the Setup Tool

1. Connect the unit and your host PC to a LAN (local-area network) using standard Ethernet patch cables.
2. Run the **NetBurner IP Setup Tool**.
3. You should see something similar to the dialog shown in [Figure 9-1](#) below. This dialog shows a NetBurner module fresh from the Wohler factory.

Figure 9–1 NetBurner IPSetup Dialog - Unconfigured

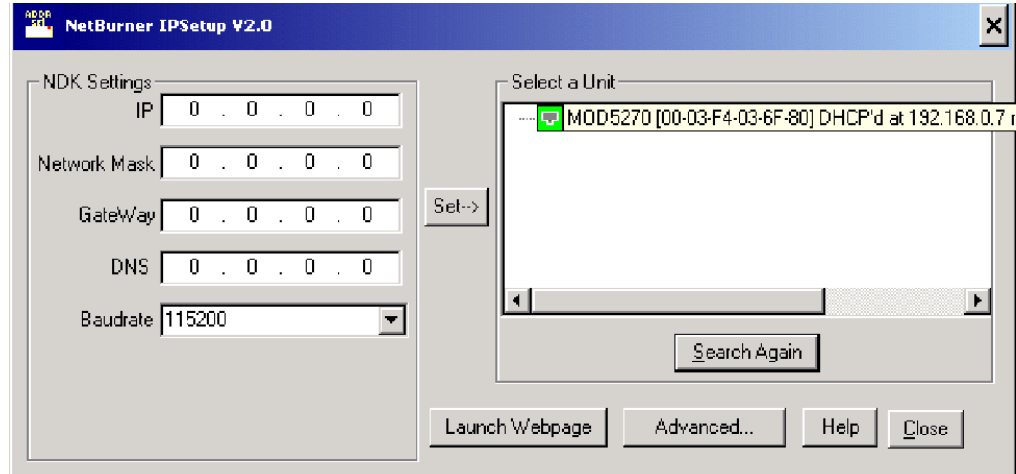

4. If multiple NetBurner modules appear in the **Select a Unit** box, be sure to note which IP address belongs to the AMP1-16V you wish to update.

Decision Point:

If you wish to use the DHCP address provided by the LAN, the AMP1-16V is now connected and you are finished with this procedure.

Otherwise, if you wish to set a static IP address instead, continue on to the next section.

Setting a Static Ethernet Configuration

1. An IP address of 0.0.0.0 means the Netburner is using DHCP addressing, and the network will give the module its address (as it has in the example in Figure 9–1 above: 192.168.0.7). When using a direct connection, you must use a static Ethernet configuration. In some fixed installations and networks, it may also be desirable to have a static Ethernet configuration in the unit. If you desire to use a static Ethernet configuration AND connect to a LAN, you MUST first obtain an address and mask from your network administrator. Failure to do so may result in intermittent problems throughout your network.
2. For our example, we'll be using the address 192.168.0.2 with the network mask of 255.255.255.0. Simply type the IP address into the **IP** field and the network mask into the **Network Mask** field. The GateWay and DNS addresses are not used by the AMP1-16V, and may be left set to 0.0.0.0.

Appendix 9 Establishing Connectivity Connecting to a LAN

Figure 9–2 NetBurner IPSetup Dialog - With IP Address and Net Mask

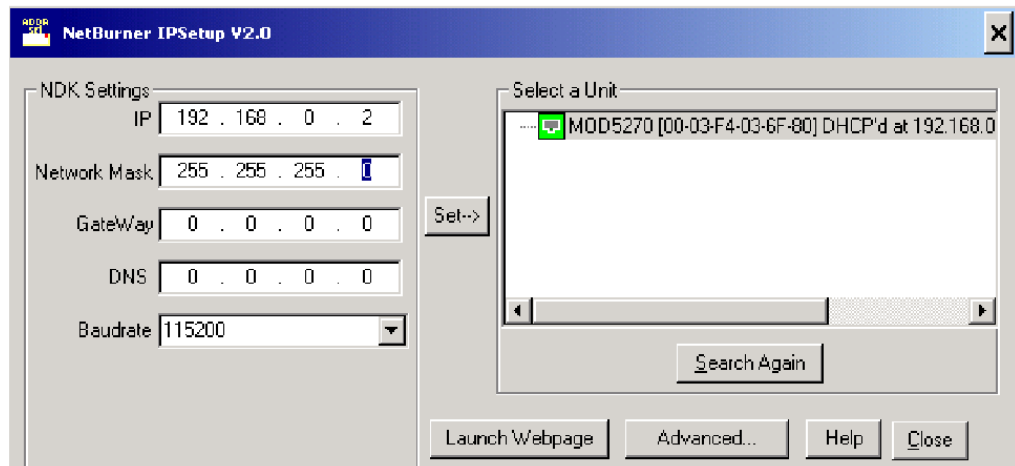

3. Press the **Set** button and wait approximately 30 seconds. If the NetBurner module does not appear with the new address, press the **Search Again** button. The window should now look like the one shown in Figure 9–3 below.

Figure 9–3 NetBurner IPSetup Dialog - New Address Accepted

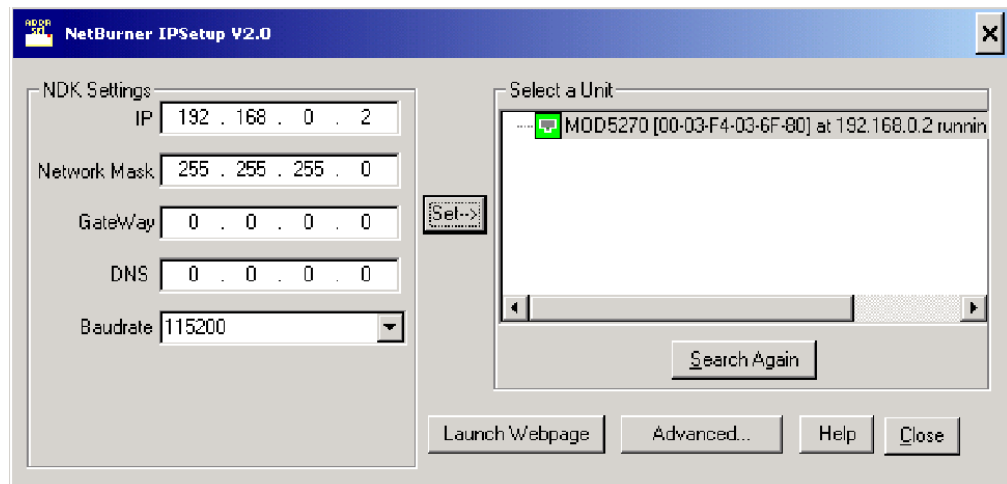

4. Close the **NetBurner IPSetup** utility by pressing the **Close** button.

Important: This concludes the procedure for establishing network connectivity to the LAN. Return to your previous location in this document.

Connecting Directly

This set of instructions describes how to connect a Windows PC directly to an AMP1-16V. Direct connections are not as easy to accomplish as network connections. Therefore, these instructions should only be used if the AMP1-16V does not have access to a LAN (Local Area Network) with a DHCP server (Dynamic Host Control Protocol – supplies IP information to devices on the LAN automatically), or if a portable router with such a server in it is not available.

For all direct connections, you will need a crossover cable rather than a standard “patch” cable. A crossover cable has two wire pairs reversed between one end and the other. They typically have a label that says “Crossover,” since they are otherwise difficult to distinguish from standard patch cables.

To connect directly, the unit must be capable of using AutoIP (see requirements in next section) or compatible static IP addresses must be used in both the computer and the unit. See [Setting a Static Ethernet Configuration on page 115](#) to set the unit, and refer to either [Setting a Static IP in a Windows XP Computer on page 121](#) or [Setting a Static IP in a Windows 7 Computer on page 126](#) for setting a static IP in your computer.

Using AutoIP

If your AMP1-16V has Version 3.10 or later installed, it has AutoIP capability. Windows XP and Windows 7 computers also have this capability, which allows the computer and the unit to auto-negotiate their IP information, and begin communicating over the crossover cable. The unit must be set for DHCP (Refer to [Launching the Setup Tool on page 114](#)) and it must have Application Version 3.10 or later. If either one of these is not true, AutoIP will not be available, and you must use one of the connection methods mentioned in [Connectivity Options on page 114](#).

1. If the computer is running, shut it down.
2. If you wrote down a static IP in the section above, you need to set the AMP1-16V for DHCP (using the **Set for DHCP** button in the **Ethernet Setup Screen**) and allow the AMP2-16V to restart.

Appendix 9 Establishing Connectivity

Connecting Directly

3. Once the AMP1-16V has restarted, please remove the power cord once again.
4. Connect the crossover Ethernet cable directly between the computer's Ethernet port and the AMP1-16V's Ethernet port. The Ethernet jack is labeled as "CMD NET" on the back of the AMP1-16V.
5. Apply power to the AMP1-16V, and let it fully boot.
6. Apply power to the PC and allow it to fully boot.
7. Your computer should have a network icon in the system tray that indicates the state of the network connection. These icons mean the computer is trying to establish a connection.

- Windows XP:



- Windows 7:



8. You must wait until the connection is established. This happens when the icon changes to one of these two:

- Windows XP:



- Windows 7:



9. The exclamation point on the icon simply signifies that the computer is not connected to the internet, which should be true if this adapter is connected directly to the unit.
10. Run the **IP Setup Utility**.
11. You should see the AMP1-16V appear with a 169.254.xxx.xxx address. The last two octets are randomly generated, and mutually agreed upon by the PC and the unit. If the unit appears in the **Select a Unit** window, your connection is successful.

12. Once you have a connection to the AMP1-16V, you may begin any software updates or preset transfers.

Decision Point:

When you have completed the software updates or preset transfers you wanted, and you are finished, **be sure to restore any settings that were changed.** After you do that, you are finished with this procedure and with this document.

If you get a failed or timeout error message, you will need to use one of the other methods that follow in the next steps. Some computers simply cannot negotiate the AutoIP protocol in a timely manner.

13. If you need to update multiple AMP1-16V units by unplugging and replugging the crossover cable, be sure to either restart the computer when changing between AMP1-16V units, or reset the network interface in the computer between changes.
14. If you cannot get a connection to the AMP1-16V, close the **Wohler IP Setup Utility** and wait a few minutes. Open it again, and try the **Search Again** button.
15. If you still do not see the AMP1-16V, check your system's network control panel. Disable any network adapters that you are not using, such as wireless adapters or other wired adapters. Restart the computer, and try again. Be sure to re-enable those adapters when you are finished. An adapter that has a connection to the internet will take precedence over one that does not (such as the direct connection between the unit and your computer).
16. If you still do not see the AMP1-16V, ensure that the network adapter in the computer you are using is set for DHCP. If it is set with a static IP, please write it down in the space on the first page, set it to DHCP, restart the computer, and try again. A static IP setting will prevent the computer from trying to use AutoIP, and likely will be a setting that will not allow the computer to communicate with the AMP1-16V.
17. If you still do not see the AMP1-16V, please try the instructions starting with [Setting a Static IP in the AMP1-16V on page 120](#).

Setting a Static IP in the AMP1-16V

In order to make a direct connection with units that have an Application Version earlier than 3.10, you must FIRST set a static IP in the unit. In order to do this, both the unit and the computer must be connected to a LAN. This will allow you to set a static IP as shown in the instructions which begin on Page 114. Once the unit has a static IP (does not report an IP address of 0.0.0.0 in the Ethernet Information Window), you can set up a direct connection with a PC as follows:

IP Address	169.254.001.001
IP Mask	255.255.0.0
Gateway	0.0.0.0
DNS	0.0.0.0

Setting a Static IP in a Windows XP Computer

1. Open the **Start** menu and choose the **Control Panel**.
2. Choose the **Network and Sharing Center**.
3. In the upper-left corner, click on the text “Change adapter settings”
4. You should see a window similar to the one in [Figure 9-4](#):

Figure 9-4 Windows XP Network Connections.



5. Disable all network adapters except the one that you are using. To do this, right click on the adapter’s icon, and choose “Disable.”
6. Right click on the adapter that you are using (It should say “Local Area Connection” as highlighted in the image above) and choose “Properties.” A window similar to the one in [Figure 9-5 on page 122](#) will open.

Appendix 9 Establishing Connectivity
Setting a Static IP in a Windows XP Computer

Figure 9–5 Windows XP Local Area Connection Properties

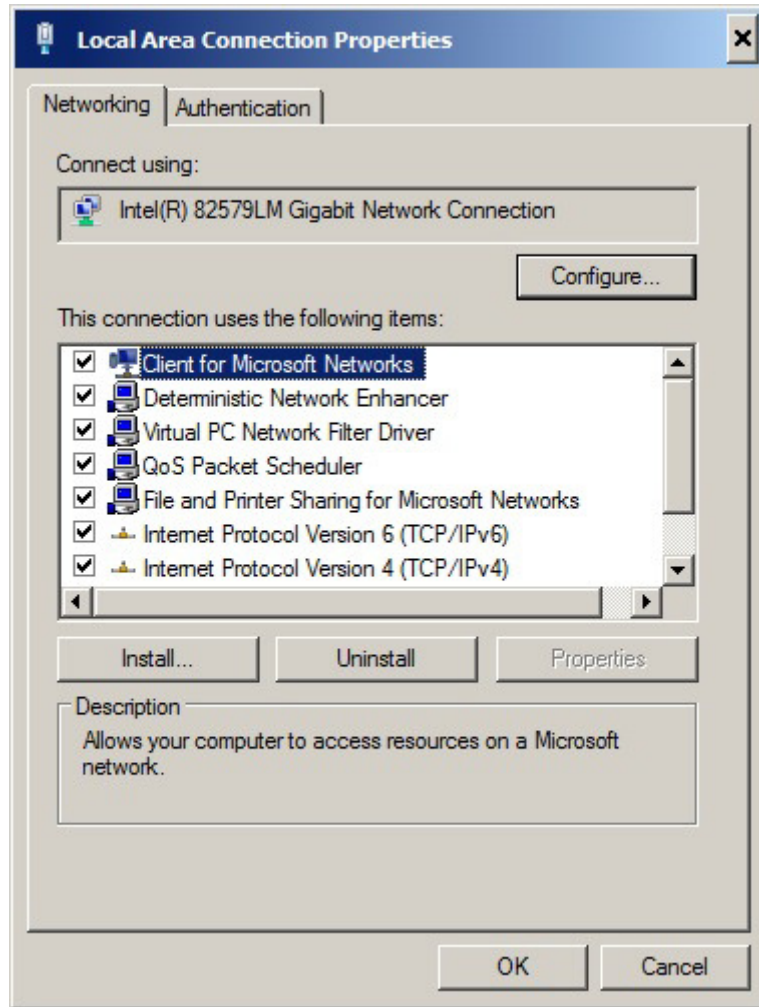

7. Right-click on the “Internet Protocol Version 4” text, and choose “Properties.” A dialog like the one in [Figure 9–6 on page 123](#) will open.

Figure 9–6 Windows XP IP Properties

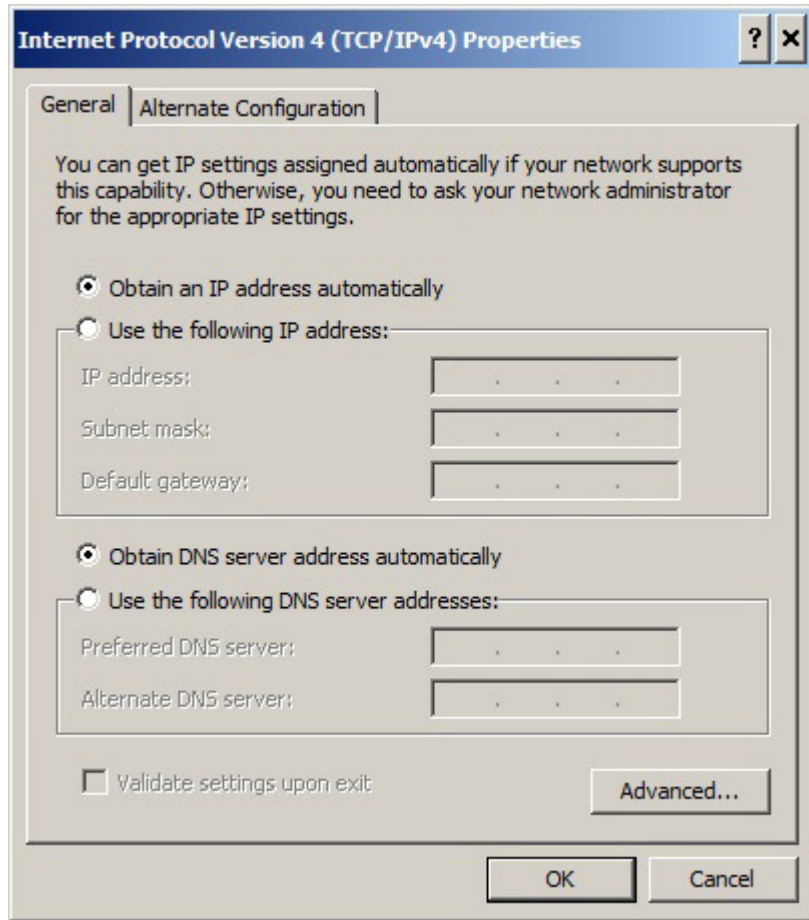

8. If there is any information in the fields above, write it here so the settings can be restored later:

IP Address	
Subnet Mask	
Default Gateway	
Preferred DNS Server	
Alternate DNS Server	

9. Set the window as shown in [Figure 9–7 on page 124](#).

Appendix 9 Establishing Connectivity

Setting a Static IP in a Windows XP Computer

Figure 9–7 Set Windows XP IP Properties

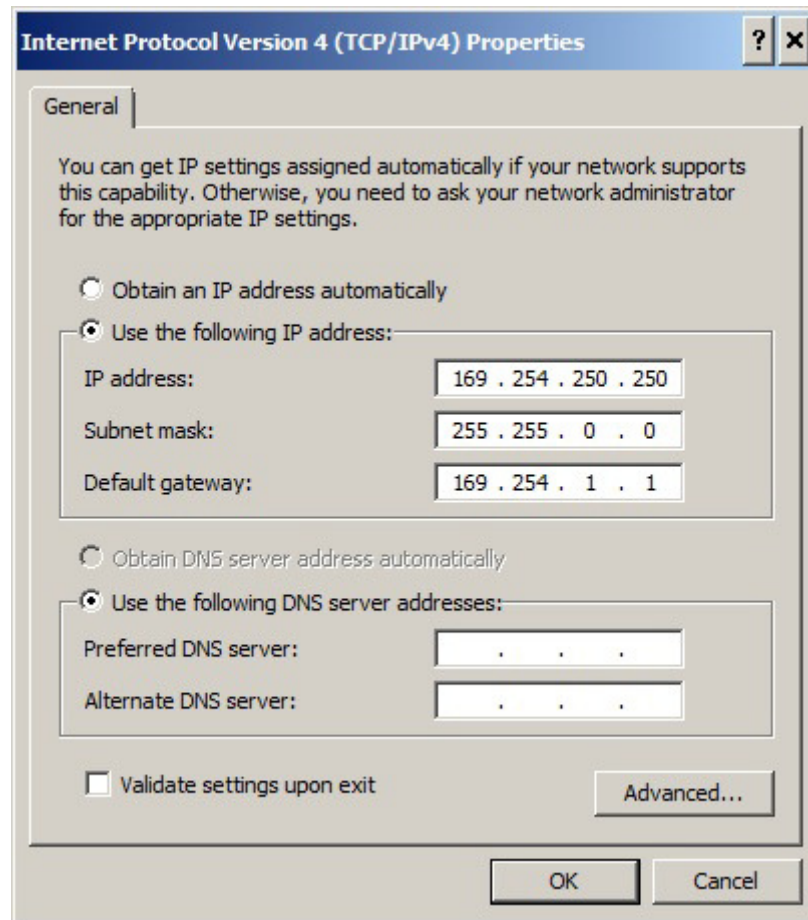

10. Press **OK** and close all other windows.
11. Shut down the computer.
12. Unplug the power to the AMP1-16V.
13. Connect the crossover cable between the computer's Ethernet port and the unit's Ethernet port (labeled as CMD NET on the back of the AMP1-16V).
14. Apply power to the AMP1-16V and allow it to fully boot.
15. Start up the computer and allow it to fully boot.

Appendix 9 Establishing Connectivity

Setting a Static IP in a Windows XP Computer

16. Your computer should have a network icon in the system tray that indicates the state of the network connection. This icon means the computer is trying to establish a connection:



17. You must **wait** until the connection is established. This happens when the icon changes to this one:



18. The exclamation point on the icon is OK. This simply signifies that the computer is not connected to the internet, which should be true if this adapter is connected directly to the AMP1-16V.
19. Open the **IP Setup Utility**.
20. You should see your unit listed in the **Select a Unit** window.
21. If not, close the **IP Setup Utility**, wait a few minutes, and try again. Your computer's network interface may take a bit of time to negotiate with the AMP1-16V.
22. When you are finished updating the AMP1-16V, return both the computer's and the AMP1-16V's IP setup to the original settings you made note of earlier.

Setting a Static IP in a Windows 7 Computer

1. Open the **Start** menu and choose the **Control Panel**.
2. Choose the **Network and Sharing Center**.
3. You should find a sub-heading titled, “LAN or High-Speed Internet.” The window will look similar to [Figure 9-8](#).

Figure 9-8 Windows 7 Network Connections.

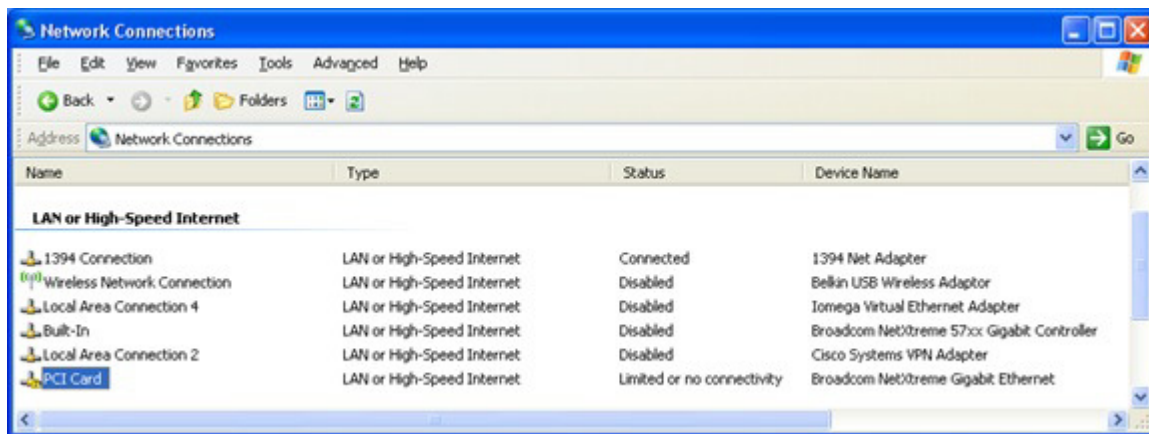

4. Disable all network adapters except the one that you are using. To do this, right click on the adapter’s icon, and choose “Disable.”
5. Right click on the adapter that you are using (such as the one highlighted in [Figure 9-8](#) above) and choose “Properties.” A window similar to the one in [Figure 9-9](#) on page 127 will open.

Figure 9–9 Windows 7 PCI Card Properties

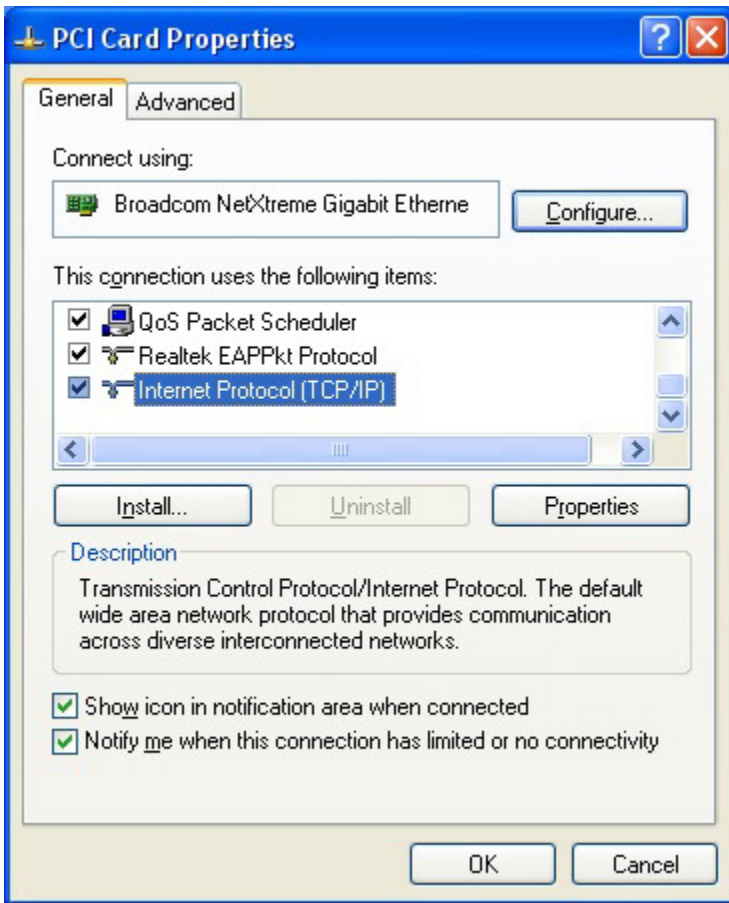

6. Click on “Internet Protocol (TCP/IP)”.
7. Click on the **Properties** button. Another dialog will open like the one shown in [Figure 9-10 on page 128](#).

Appendix 9 Establishing Connectivity
Setting a Static IP in a Windows 7 Computer

Figure 9–10 Windows 7 Internet Protocol Properties

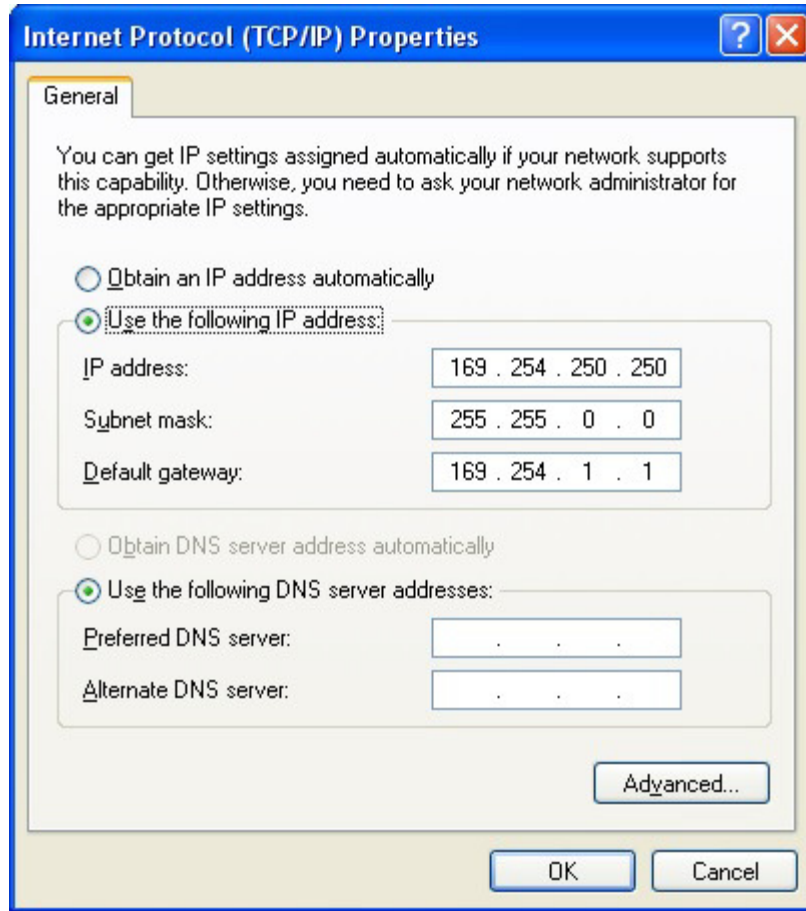

8. If there is any information in the fields above, write it here so you can restore the settings later:

IP Address	
Subnet Mask	
Default Gateway	
Preferred DNS Server	
Alternate DNS Server	

9. Set the window with the settings shown in [Figure 9-10](#) above.
10. Press **OK** and close all other windows.
11. Shut down the computer.
12. Unplug the power to the AMP1-16V.

Appendix 9 Establishing Connectivity Setting a Static IP in a Windows 7 Computer

13. Connect the crossover cable between the computer's Ethernet port and the unit's Ethernet port (labeled as CMD NET on the back of the AMP1-16V).
14. Apply power to the AMP1-16V and allow it to fully boot.
15. Start up the computer and allow it to fully boot.
16. Your computer should have a network icon in the system tray that indicates the state of the network connection. This icon means the computer is trying to establish a connection:



17. You must wait until the connection is established. This happens when the icon changes to this one:



18. The exclamation point on the icon is OK. This simply signifies that the computer is not connected to the internet, which should be true if this adapter is connected directly to the unit.
19. Open the **IP Setup Utility**.
20. You should see your unit listed in the **Select a Unit** window.
21. If not, close the **IP Setup Utility**, wait a few minutes, and try again. Your computer's network interface may take a bit of time to negotiate with the AMP1-16V.
22. When you are finished updating the AMP1-16V, return both the computer's and the AMP1-16V's IP setup to the original settings you noted earlier.
23. You **must** set a static IP address for the AMP1-16V as described in [Setting a Static Ethernet Configuration, Step 1 \(page 115\)](#). We suggest you enter 169.254.1.1. You must also set the mask to the same value set in [Setting a Static Ethernet Configuration in Step 2 \(page 115\)](#). We suggest you enter 255.255.0.0.
24. When you are finished with the file transfer(s), you should return all the IP address and network mask fields to their original values.

Important: This concludes the procedure for establishing direct network connectivity. Return to your previous location in this document.

Appendix 9 Establishing Connectivity

Setting a Static IP in a Windows 7 Computer

APPENDIX 10

Setting Up File Transfers

Introduction

Overview

This appendix explains how to set up the AMP1-16V-MD Series monitor to transfer files to or from a PC through an Ethernet connection. See [Appendix 9 on page 113](#) for establishing connectivity to the PC.

Topics

Topics	Page
Introduction	131
Navigating to the Unit Information Menu	132
Enabling FTP Access	133

Navigating to the Unit Information Menu

1. Power the AMP1-16V and navigate to the **Unit Information Menu**. From the **Main Screen**, press the checkmark button to get to the **Configuration Selection Menu**. Then follow this menu navigation: **Screen Display Menu** -> **Option Menu** -> **Hardware Config** -> **Unit Info SW Upgrades**. It will appear as shown in [Figure 10-1](#) below.
2. When the **Unit Information Menu** appears, press the **S/W Update** button to display the **ENABLE FTP** button.

Figure 10-1 Unit Information Menu

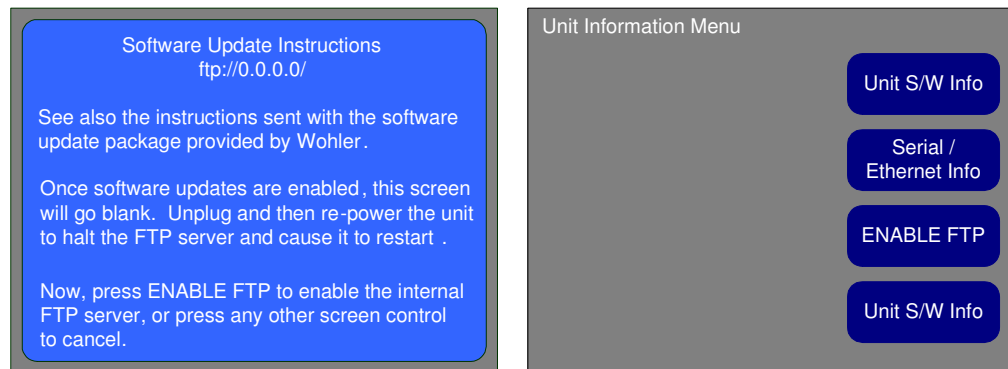

3. Note the line of text at the top of the window with the FTP address. It should read something like ftp://192.168.0.2/.

Important: If the address comes up as ftp://0.0.0.0/, the unit is using DHCP in a peer-to-peer connection, or no Ethernet connection exists. Refer to Step 1 in [Setting a Static Ethernet Configuration on page 115](#).

Write it here: _____

4. If the AMP1-16V's graphics screens remain black after the unit has had power applied for more than thirty seconds, you will need to get the IP address and mask of the unit using the IP Setup tool, as described in the [Setting a Static Ethernet Configuration on page 115](#).

Enabling FTP Access

If the unit's graphics screens remain black after the unit has had power applied for more than thirty seconds, the unit is already in FTP mode. You may skip Step 1.

1. On the AMP1-16V, press the **ENABLE FTP** button.
Note: Pressing the **ENABLE FTP** knob will cause the monitor's display to go dark.
2. On the PC, open **My Computer** from the Windows desktop.
3. In the **Address** line, enter the address you wrote down in Step 3 (on the previous page), exactly as noted. For example, enter ftp://192.168.0.2.
4. You will see something similar to the following screen shot in [Figure 10-2](#), if the folders are set to detail view. The filename, folder name, and file sizes below are accurate. All other attribute information, especially the dates, are bogus and should be ignored.

Figure 10-2 FTP Location

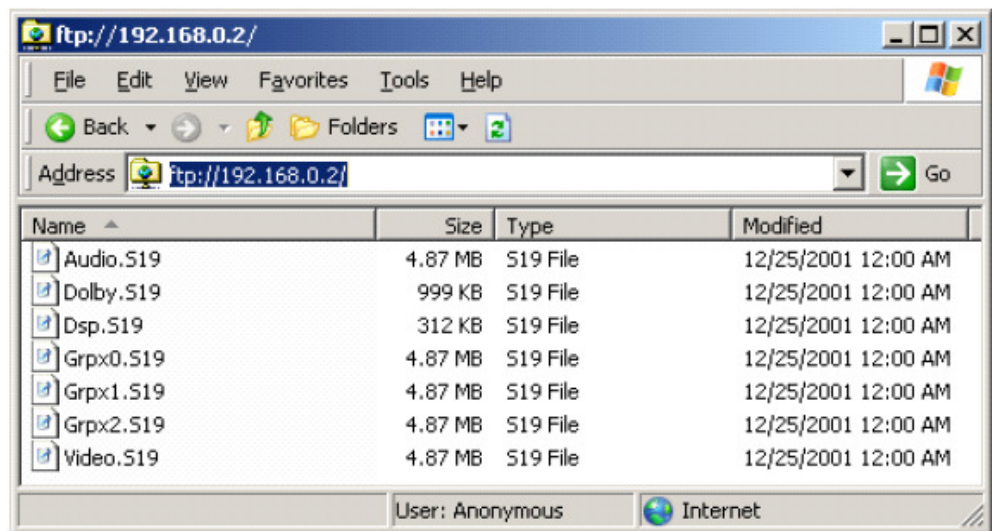

5. If you see the following dialog similar to the one in [Figure 10-3](#) after a minute or so, it means the FTP connection failed. Try power cycling the unit, and repeating the steps (1 through 4) above. When you get back to this point, press the F5 key to refresh the window.

Appendix 10 Setting Up File Transfers

Enabling FTP Access

6. If the unit still fails to connect, double check all physical connections, and try using the **IP Setup** tool to discover the unit's IP address and mask.

Figure 10–3 Failed FTP Connection

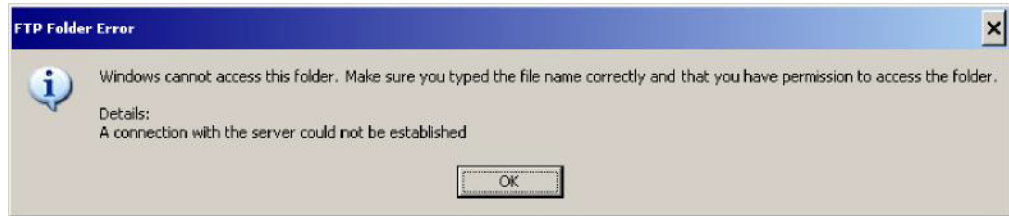
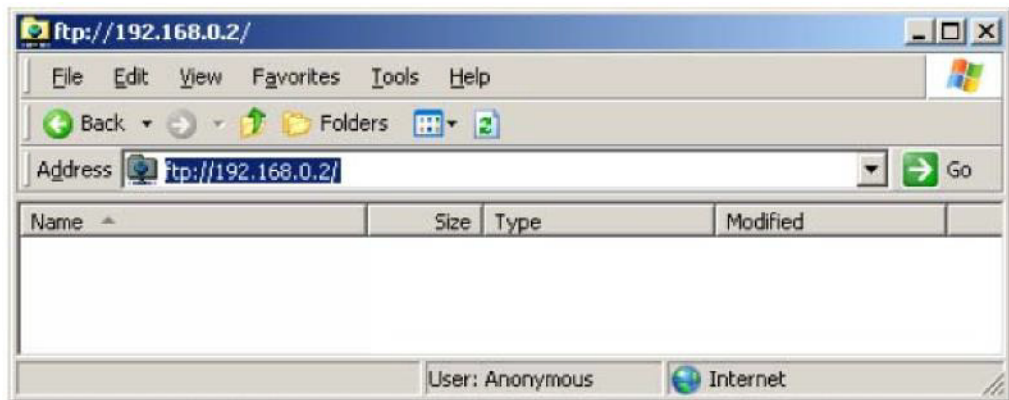

Figure 10–4 FTP Window



7. Press the F5 key to refresh the window.

Important: You must refresh the file window after each file transfer since Windows caches the file and folder information. If any of the files change, Windows will report the previous information from its cache rather than the current information. Refreshing the folder after each file change resolves this issue.

Important: This concludes the ftp setup procedure. Return to your previous location in this document.